

Transponder-coded safety switches

Interlocking devices and guard locking devices



EUCHNER

More than safety.

EUCHNER

More than safety.



Headquarters in Leinfelden-Echterdingen



Logistics center in Leinfelden-Echterdingen



Production location in Unterböhringen

Internationally successful – the EUCHNER company

EUCHNER GmbH + Co. KG is a world-leading company in the area of industrial safety technology. EUCHNER has been developing and producing high-quality switching systems for mechanical and systems engineering for more than 60 years.

The medium-sized family-operated company based in Leinfelden, Germany, employs around 750 people around the world.

17 subsidiaries and other sales partners in Germany and abroad work for our international success on the market.

Quality and innovation – the EUCHNER products

A look into the past shows EUCHNER to be a company with a great inventive spirit. We take the technological and ecological challenges of the future as an incentive for extraordinary product developments.

EUCHNER safety switches monitor safety doors on machines and installations, help to minimize dangers and risks and thereby reliably protect people and processes. Today, our products range from electromechanical and electronic components to intelligent integrated safety solutions. Safety for people, machines and products is one of our dominant themes.

We define future safety technology with the highest quality standards and reliable technology. Extraordinary solutions ensure the great satisfaction of our customers.

The product ranges are subdivided as follows:

- ▶ Transponder-coded Safety Switches
- ▶ Transponder-coded Safety Switches with guard locking
- ▶ Multifunctional Gate Box MGB
- ▶ Access management systems (Electronic-Key-System EKS)
- ▶ Electromechanical Safety Switches
- ▶ Magnetically coded Safety Switches
- ▶ Enabling Switches
- ▶ Safety Relays
- ▶ Emergency Stop Devices
- ▶ Hand-Held Pendant Stations and Handwheels
- ▶ Safety Switches with AS-Interface
- ▶ Joystick Switches
- ▶ Position Switches



General	4	
Selection criteria	5	
Safety switches without guard locking	10	
Safety switches with guard locking	11	
Function expansion	12	
System Family A	14	A
Safety switch CES-A-5...	16	
System Family AH	18	AH
Safety switch CES-AH-C03-...	20	
System Family AP	22	AP
Safety switch CES-AP-C01-...	24	
Safety switch CES-AP-C.2-...	26	
Safety switch CES-I-AP-.C04-...	30	
Safety switch CTP-...-AP-...	34	
Safety switch CET.-AP-...	44	
System Family AR	52	AR
Safety switch CES-AR-C01-...	54	
Safety switch CES-AR-C.2-...	56	
Safety switch CES-I-AR-.C04-...	60	
Safety system ESL-IH-AR-...	64	
Safety switch CEM-I2-AR-.C40-...	66	
Safety switch CTP-L.-AR-...	68	
Transponder-coded safety switch CET.-AR-...	76	
AR evaluation unit CES-AR-AES-12	86	
System Family AY	88	AY
Safety switch CEM-I2-AY-.C40-...	90	
Accessories	92	
Connection material	94	
Bolts	108	
Fixing material	114	
Miscellaneous accessories	116	
Index	120	
Index by item designation	120	
Index by order number	123	

CES technology from the inventor of transponder-coded safety engineering – transponder-coded safety systems from EUCHNER

The transponder-coded safety systems from EUCHNER are modern interlocking devices or guard locking devices of type 4 for the protection of people, machines and processes. They are based on non-contact transponder technology and consist of a coded actuator, a read head and evaluation electronics. In some systems, the read head and evaluation electronics form a self-contained unit. All safety functions are combined in a single component here (internal evaluation). With external evaluation, the actuator is read via a separate read head connected to an evaluation unit in the control cabinet.

Internal evaluation

Transponder signals are evaluated in the field, not in the control cabinet. All devices in this catalog have internal evaluation.

External evaluation

With external evaluation the evaluation electronics for the transponder signals are accommodated in a separate housing. This separation minimizes the read head's size. This is particularly advantageous if the available space at the location to be protected is very limited.

You will find more information on these devices in the catalog for “Transponder-coded safety systems with external evaluation” or at www.euchner.com.

The advantages of transponder-coded safety switches

Transponder-coded safety switches from EUCHNER provide the following advantages:

- Maximum protection against tampering due to uniquely coded actuator
- Highest safety category and Performance Level (PL) according to EN ISO 13849-1.

- Depending on the application, a device with a suitable operating distance can be selected.
- The large operating distance offers greater door guide tolerance.
- The actuator can be rotated within the read head's operating distance.
- Less sensitive to dirt on the surface.
- Less susceptible to vibration and shock.
- Can be used in harsh environment.
- Suitable for areas with increased hygiene requirements.

Type examinations and approvals

EUCHNER is allowed to undertake CE certification for almost all products without the involvement of a notified body, as EUCHNER is allowed to use the system for full quality assurance according to Annex X of the Machinery Directive. This procedure has been confirmed by TÜV Rheinland and is checked regularly. Nevertheless, additional type examinations are undertaken by a notified body such that an independent body again confirms that all laws and standards are met.

Many of the devices listed in this catalog have been tested for instance by the German Social Accident Insurance association (DGUV), formerly the employers' liability insurance association (BG), and are given in the lists from the DGUV.

For countries outside the EU, multiple approvals are necessary for safety products. Many of the products are listed by Underwriters Laboratories (UL) or are marked according to the EurAsian Conformity (EAC) standard.

The approval symbols on the individual pages of the catalog indicate which tests and approvals are available and which body tested the devices. With the aid of the approval symbols listed below you can quickly see which approvals are available for the related device:



You will find further information on the topic of directives and standards in the Service area at www.euchner.com.

Selection criteria

System families

System family A

A System family A is characterized by the ability to switch through clock pulses from safe control systems via its semiconductor outputs.

The clock pulses at the control system outputs do not have to be switched off. Up to three devices can be connected in series.

System family AH

AH System family AH was specially developed for switching high currents. This permits direct switching of contactors and loads without additional safety relay. Each of the two outputs can withstand a load of 3.5 A.

In operation the device regularly switches off the safety outputs for a few milliseconds to check the safe switching function.

System family AP

AP The system family AP is intended to be used for separate operation. The devices are particularly suitable for the connection of safety evaluation units and safety control systems that require short test pulses. Some versions have been optimized for connection to decentralized

peripheral systems, such as the ET200pro series from Siemens. The AP devices generate test pulses on the safety outputs for short circuit monitoring. Due to the little wiring work, AP devices represent a low-cost solution.

Connection examples

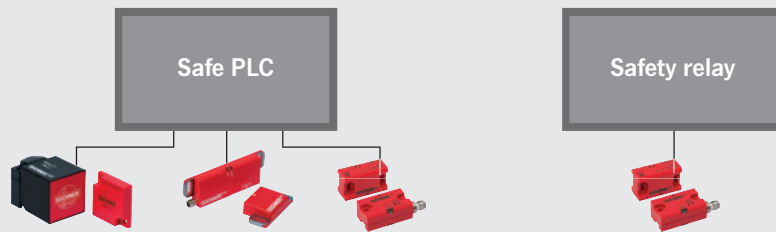

System family AR

AR In the AR version up to 20 devices belonging to the AR system family can be connected in series. Category 4/PL e is achieved for series connections with up to 20 devices. The AR devices generate test pulses on the safety outputs for short circuit monitoring.

If the evaluation unit is used, the monitoring signals can be evaluated as well. Instead of the Y-plug connectors it is also possible to use a passive distribution module.

With this device, safety and status signals are collected together in the field and forwarded to the control system.

Two different concepts for connection are available:

■ Series connection in the field

For field wiring EUCHNER offers the option of using M12 plugs and Y-distributors to connect together several AR devices. The safety outputs can be connected either directly to a control system or to the AR evaluation unit.

■ Series connection in the control cabinet

Wiring takes place in the control cabinet. All information about the status of individual AR devices can be forwarded directly to the control system.

Examples for series connection in the field

Series connection with Y-distributors and connection to several safe PLCs or safety relays

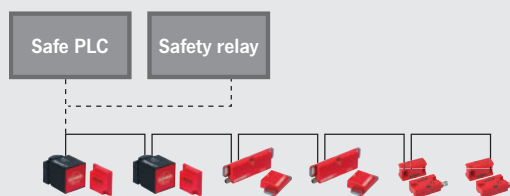

Series connection with Y-distributors and connection to AR evaluation unit

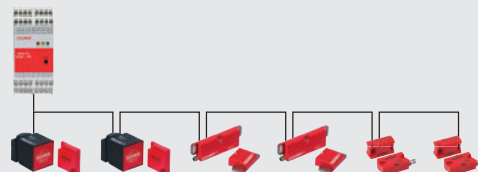

Series connection with passive distribution module and connection to safe PLCs or safety relays

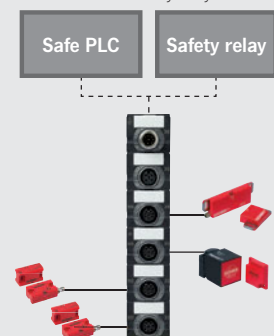

System family AS (AS-Interface Safety at Work)

AS Version with integrated AS-Interface. The safety switch is connected directly to the ribbon cable via an AS-i coupling module. The wiring work is therefore reduced to a minimum, as all information on the safety switch is made available to the control system via the AS-Interface.

You will find more information on devices with AS-Interface in the catalog for “Safety switches with AS-Interface” or at www.euchner.com.

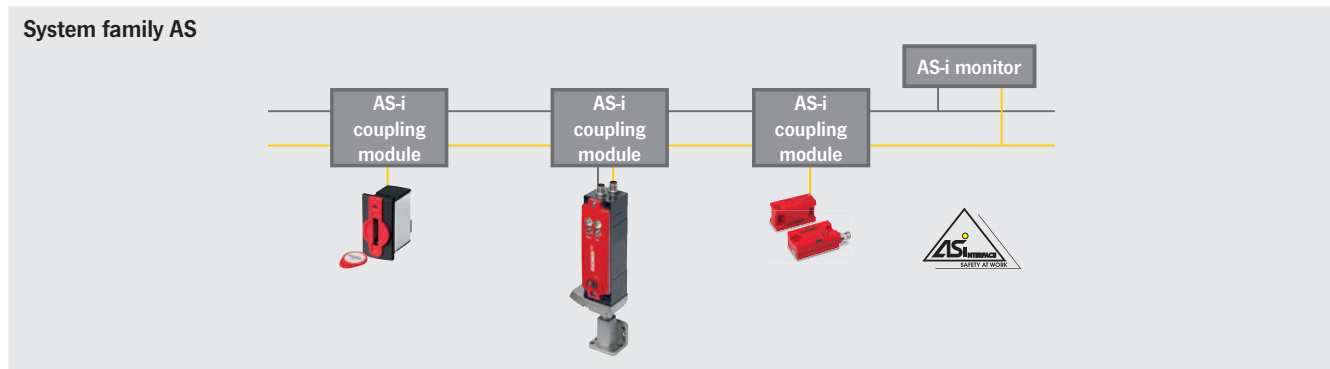

System family AY

AY AY devices are intended to be used for separate operation. The AY devices generate test pulses on the safety outputs for short circuit monitoring. The test pulses are longer than on AP devices.

Coding

Each transponder actuator from EUCHNER features unique coding and significantly surpasses the requirement in EN ISO 14119 for a type 4 switch with high coding level. The code in an actuator cannot be reprogrammed.

Unicode evaluation

With the unicode version, the actuators must be taught-in on the safety switch. During the teach-in operation the actuator code is assigned to the safety switch. This code is saved in the safety switch. Whenever an actuator is read, the safety switch compares the code just read with the code last saved. The actuator is recognized and the safety outputs/status signals are switched only if the two bit patterns are identical. The number of possible teach-in operations is dependent of the safety switch used. Only the last actuator taught in is detected. Unicode detection provides a high level of protection against tampering.

Fixcode evaluation

With fixcode devices, the teach-in operation is performed at EUCHNER prior to delivery. An actuator is permanently assigned to the device in this process. The device can be operated only with this one actuator. No additional actuators can be taught in.

Multicode evaluation

Unlike systems with unique code detection, with multicode evaluation a specific actuator code is not requested, instead it is only checked whether the actuator is of a suitable type that can be detected by the system (multicode detection). There is no exact comparison of the actuator code with a code saved in the evaluation unit. As a result a teach-in operation for the actuator is not necessary.

Operating distance and active face

The operating distances indicate the distance between the actuator and sensor from which a switching process is triggered. The active faces on the actuator and switch define these distances. The faces must be parallel to each other on approach.

Approach directions

Dependent on the housing design, the devices have one or more active faces and therefore one or more possible approach directions.

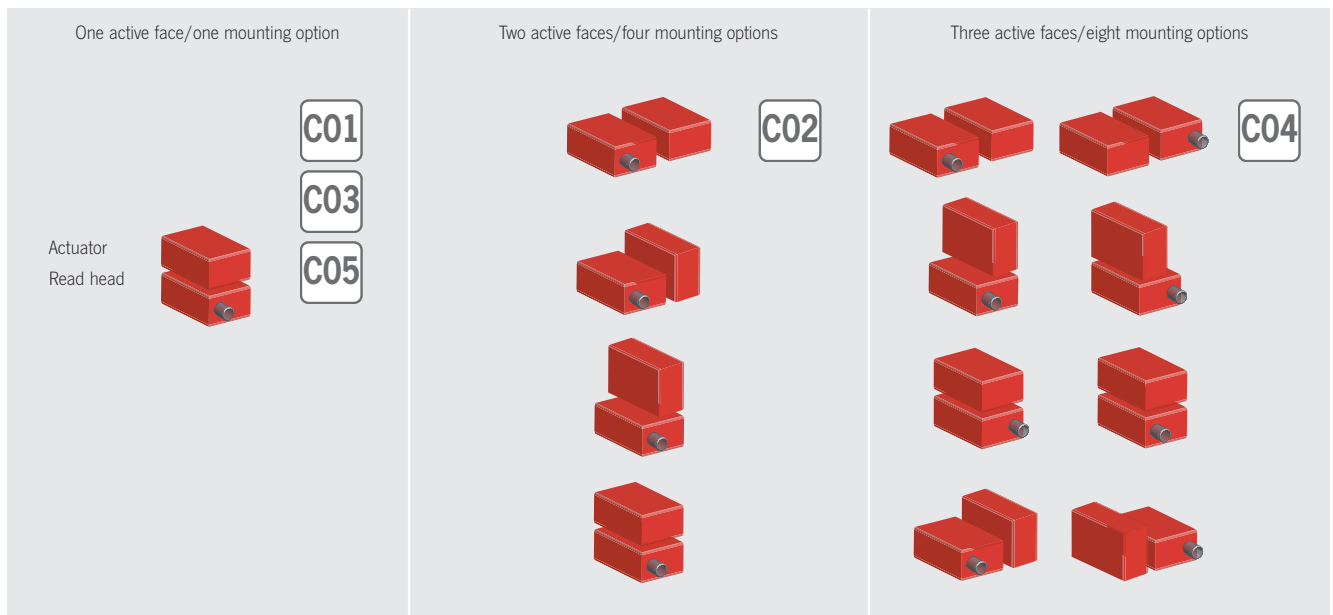

The transponder field

Transponder-coded systems operate using electromagnetic fields. These fields differ depending on the design of the device.

Switch-on distance, switch-off distance and hysteresis

On moving an actuator toward a switch, a switching signal is triggered on reaching the switch-on distance. The actuator is detected and the safety outputs are switched on.

If the actuator is removed again from the field, the safety outputs are switched off again on reaching the switch-off distance. As the switch-on distance and switch-off distance are different, there is a switching hysteresis. The larger the switching hysteresis, the less sensitive the system is to vibration.

Typical operating distance

Each system has typical and assured operating distances. The assured operating distances are defined in the EN 60947-5-3 standard and are briefly explained in the following.

The information in the catalog corresponds to the typical operating distance.

Assured operating distance s_{ao}

According to EN 60947-5-3, the assured operating distance is the distance from the active sensor face within which the presence of the actuator is correctly detected under all defined environmental conditions and manufacturing tolerances.

Assured switch-off distance s_{ar}

According to EN 60947-5-3, the assured switch-off distance is the distance from the active sensor face outside which the actuator is no longer detected under any environmental conditions, manufacturing tolerances and fault conditions, so that the system switches off.

Limit-range indication

The device detects if the actuator wanders out of the operating distance and indicates that the actuator is in the limit range by flashing the STATE LED. This allows the safety door to be readjusted in time.

Side lobes

Transponder fields in general comprise a main field and secondary fields (so-called side lobes). The secondary fields are significantly smaller than the main field and are to the side of the main field. A transponder is also read if it is in a secondary field. This effect is undesirable and on the very close, side approach of an actuator causes problems because the actuator is read before it has reached the main field (and therefore the intended position).

Surrounding material and installation depth

The operating distance is reduced by flush, recessed installation in the surrounding material. This effect is stronger with a metallic surrounding material than with plastic, for example. Completely encapsulated installation in metal in which the active face on the transponder is covered is in general not possible, as the field is attenuated excessively.

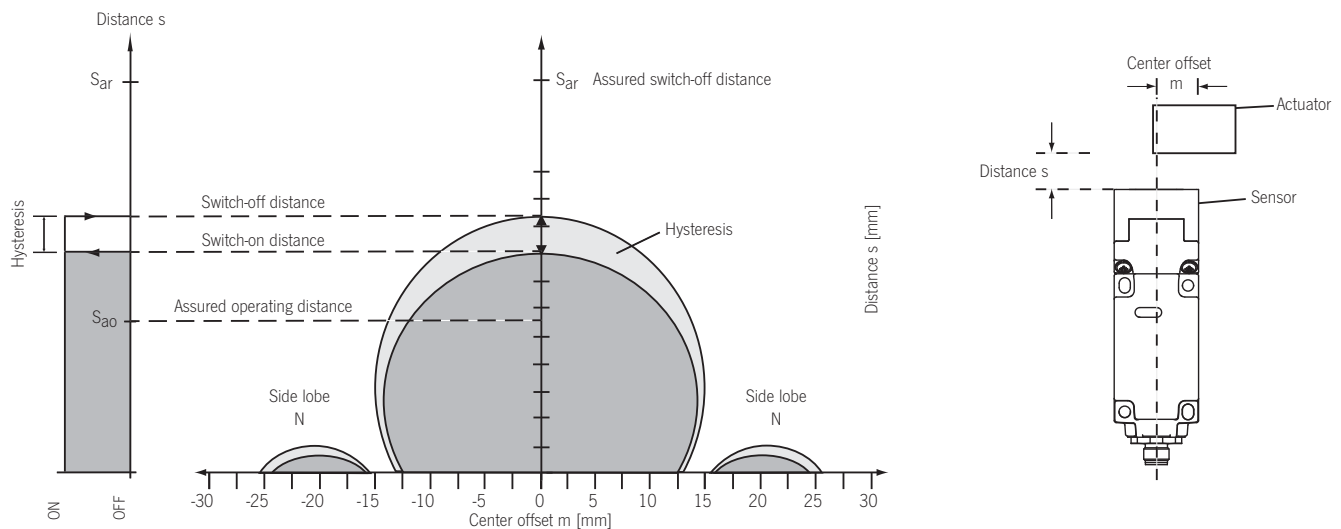

Interlocking devices and guard locking devices

Interlocking devices

Devices from the CES series are interlocking devices according to EN ISO 14119 for reliable safety guard position monitoring. Their safety outputs switch off as soon as the safety guard is opened.

Guard locking devices for process or personnel protection

As per EN ISO 14119, guard locking for personnel protection requires continuous monitoring of the guard locking function. On opening or failure of the guard locking device, the safety outputs must be switched off. Any guard locking for personnel protection can also be used as guard locking for process protection.

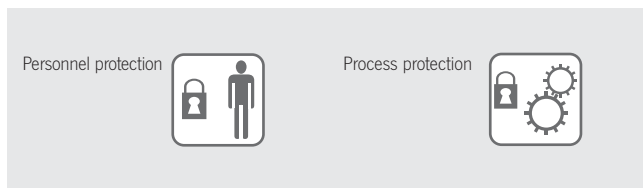

Guard locking devices for process protection are not reliably monitored guard locking devices. The safety function of these devices is limited to position monitoring for the safety door.

Monitoring the guard locking state is not part of the safety function.

Principle of operation of guard locking

EUCHNER offers two guard locking methods:

■ Electromechanical guard locking

Here a guard locking pin is moved, which prevents the removal of the actuator (form locking).

■ Magnetic guard locking

Here the actuator is held in place by the magnetic attraction force on the guard locking solenoid (force locking).

Guard locking principle

EUCHNER offers two guard locking principles:

Principle of operation	Closed-circuit current principle	Open-circuit current principle
Electromechanical guard locking	Guard locking actuated by spring force applied and power-ON released	Guard locking actuated by power-ON applied and spring released
Magnetic guard locking		Guard locking actuated by power-ON applied and released by power-OFF applied

Safety switches without guard locking

C01

- ▶ Compact, square design, standard housing (EN 60947-5-2)
- ▶ One active face; can be repositioned in five directions
- ▶ Large operating distance
- ▶ Limit-range indication
- ▶ Degree of protection IP 67

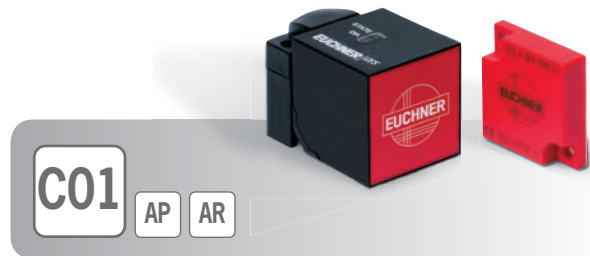

C02

- ▶ Narrow, elongated design
- ▶ Two active faces
- ▶ Direct mounting on aluminum profiles
- ▶ Limit-range indication
- ▶ Large temperature range
- ▶ Degree of protection IP 67/IP 69/IP 69K



C03

- ▶ Switches loads up to 3.5 A
- ▶ Very large operating distance
- ▶ One active face; not adjustable
- ▶ Degree of protection IP 67
- ▶ Standard housing (EN 60947-5-2)
- ▶ Start button connection



C04

- ▶ Smallest design
- ▶ Three active faces
- ▶ Limit-range indication
- ▶ Degree of protection IP 67/IP 69/IP 69K
- ▶ Actuator can be positioned in three steps by means of slot

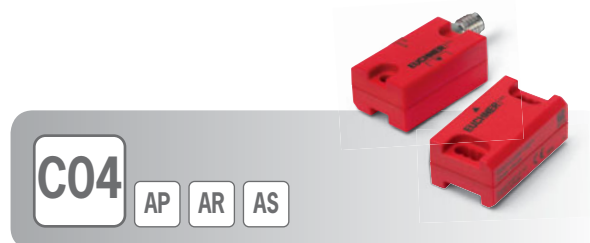

C05

- ▶ Standard housing (EN 60947-5-2)
- ▶ One active face; can be repositioned in five directions
- ▶ Very large operating distance
- ▶ Degree of protection IP 67
- ▶ ATEX version available



Safety door handle ESL

- ▶ Safety switch and door handle in one
- ▶ Very simple mounting
- ▶ Robust metal housing
- ▶ With integrated lock (depending on version)
- ▶ Degree of protection IP 67



Safety switches with guard locking

CEM

- ▶ Magnetic guard locking for process protection
- ▶ Locking force of 600 N
- ▶ Adjustable adhesive force (acts with guard locking inactive)
- ▶ Ideal for profile mounting



CTP

- ▶ Guard locking for personnel protection according to EN 14119
- ▶ Degree of protection IP 67/IP 69/IP 69K
- ▶ Fastening compatible with the EUCHNER safety switches TP, STP and STA
- ▶ Three approach directions; head can be rotated in 90° steps
- ▶ High locking force of 3,900 N
- ▶ Version with AS-Interface available



CET

- ▶ Guard locking for personnel protection according to EN 14119
- ▶ Very high locking force up to 6,500 N
- ▶ Two safety outputs (semiconductor outputs)
- ▶ Head can be rotated in 90° steps
- ▶ Degree of protection IP 67
- ▶ Metal housing
- ▶ Actuator guide with large freedom of movement
- ▶ Two-channel solenoid control permissible
- ▶ Connection via plug connectors



Function expansion

Due to the large selection of accessories and parts that can be retrofitted, additional or expanded functions are possible. You will find an overview of the accessories available in the section of the catalog on the related device.

Release functions

Some situations require guard locking to be released manually (e.g. malfunctions or an emergency). The following release functions are available for EUCHNER devices:

Auxiliary release and mechanical key release (1)

In the event of malfunctions, guard locking can be released with the auxiliary release irrespective of the state of the solenoid.

Escape release (2)

Permits opening of a locked safety guard from the danger area without tools.

Emergency unlocking (3)

Permits opening of a locked safety guard from outside the danger area without tools.

Wire front release (4)

Release via a pull wire. Depending on the type of attachment, the wire front release can be used as emergency unlocking or escape release.



Lockout bar

The lockout bar can be used to prevent maintenance personnel from being unintentionally locked in the danger area, for example. In locked position, the lockout bar prevents activation of guard locking. The lockout bar can be secured in locked position using padlocks.

Lockout bars are available in two versions:

- ▶ Lockout bar permanently mounted on the device
- ▶ Removable lockout bar for blocking the switch head or the actuator



Versatile accessories

Bolts

Bolts function as follows: the bolt tongue mechanically guides the actuator when it is inserted into the safety switch actuating head. The bolt mounted on the door frame comprises a protruding bolt tongue, the handle and the actuator, mounted offset somewhat to the rear. The switch bracket with the safety switch is fitted to the frame. The bolt absorbs forces that act on the switch and the actuator and that could damage the switch and actuator. Bolts are available for many safety switches from EUCHNER. Some as a set with pre-assembled safety switch.

Function expansions that can be retrofitted

For some devices there are function expansions that can be retrofitted, e.g. manual releases, cover plates, insertion funnels, lockout bars and much more. You can find suitable accessories for your device very simply at www.euchner.com.

Connection material

EUCHNER offers a large selection of connecting cables, plug connectors and other connection accessories. You can find suitable accessories for your device very simply at www.euchner.com.

Installation material

EUCHNER offers mounting plates and brackets for many devices for a wide variety of fastening situations. You can find suitable accessories for your device very simply at www.euchner.com.



“Connect pulsed signals via the safe semiconductor outputs on up to three safety switches in series.”

- ▶ Suitable for switching pulsed signals
- ▶ Very large operating distance
- ▶ Two safe semiconductor outputs
- ▶ Monitoring output (depending on version)
- ▶ Series connection of up to three devices possible
- ▶ Cable lengths up to 300 m possible
- ▶ ATEX version available
- ▶ PL e/category 3 or 4 according to EN ISO 13849-1



Safety switch CES-A-.5...



- ▶ **Standard housing (EN 60947-5-2)**
- ▶ **One active face, can be repositioned in five directions**
- ▶ **Diagnostics via two LEDs**
- ▶ **Large operating distance**
- ▶ **PL e/category 3 or 4**
- ▶ **ATEX version available**

Details

Available coding options

- ▶ Unicode evaluation
- ▶ Multicode evaluation

Category according to EN ISO 13849-1

Due to two redundantly designed semiconductor outputs (safety outputs) with internal monitoring suitable for:

- ▶ CES-A-C5E-01, category 3/PL e according to EN ISO 13849-1
- ▶ CES-A-C5H-01/CES-A-W5H-01, category 4/PL e according to EN ISO 13849-1

LED indicator

STATE Status
OUT/ERROR Status of safety outputs/diagnostics (combined)

Additional connections

OUT Monitoring output (semiconductor)

ATEX version

There is a version of this device for usage in potentially explosive atmospheres. For explosion protection see marking in the ordering table.

Important: Use only ATEX actuators for ATEX devices.

Notice

On devices with unicode evaluation the number of teach-in operations is restricted to eight.

Further information

- ▶ Dimension drawings see p. 17
- ▶ Accessories and spare parts see p. 17
- ▶ For detailed information, enter the order number for the product in the search box at www.euchner.com.

Ordering table

Safety switch

Series	Version	Order no./item	
CES-A-C5... Unicode	M12 8 pin	077750 CES-A-C5E-01	For detailed information, enter the order number for the product in the search box at www.euchner.com .
		091458 CES-A-C5H-01	
CES-A-W5... Multicode	097525 CES-A-W5H-01		
CES-A-C5H-01-EX Unicode	097945 ¹⁾ CES-A-C5H-01-EX		

1) II3G Ex ic nA IIB T5 Gc X, II3D Ex ic tc IIIC T90°C Dc X



Actuator

Series	Design	Typ. operating distance [mm]	Order no./item	
CES-A-BPA	40 x 40	22	098775 CES-A-BPA	For detailed information, enter the order number for the product in the search box at www.euchner.com .
CES-A-BBA	42 x 25	20	071840 CES-A-BBA	
CES-A-BCA	 Material: PE-HD	20	088786 CES-A-BCA	
CES-A-BPA-EX-102125	40 x 40	22	102125 CES-A-BPA-EX-102125	
CES-A-BBA-EX-098158	42 x 25	20	098158 CES-A-BBA-EX-098158	

M12 8 pin

C05

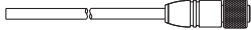
Accessories

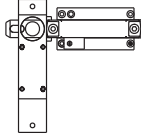
Type	Version	
Connection material	Connecting cable with plug connector 	 Page 103
Bolts	Bolts for housing design C05 	Page 108
Fixing material	Safety screws	Page 116

Dimension drawing

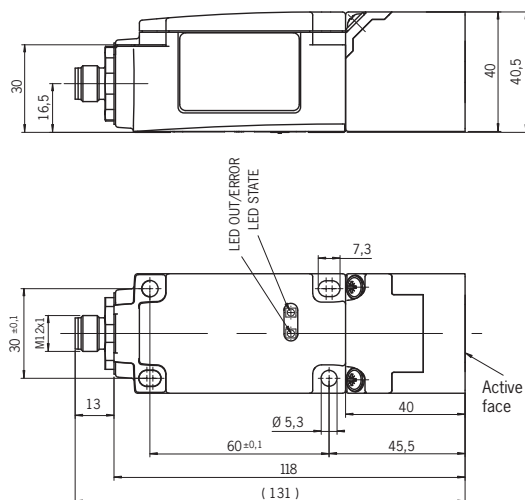

Block diagram

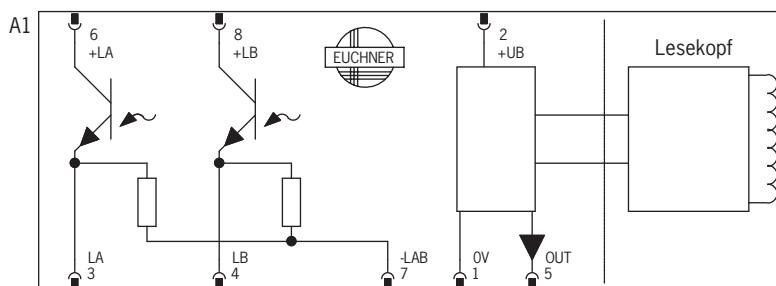

Terminal assignment

Pin	Designation	Function
1	OV	Power supply DC 0 V
2	+UB	Power supply DC 24 V
3	LA	Safety output, channel 1
4	LB	Safety output, channel 2
5	OUT	Monitoring output (door monitoring output)
6	+LA	Channel 1 input
7	-LAB	Common ground for channel 1 and channel 2 inputs
8	+LB	Channel 2 input

“The power pack – switch loads up to 3.5 A without additional relays or contactors.”

- ▶ Safety outputs with an output current up to 3.5 A for switching loads directly
- ▶ Very large operating distance
- ▶ Two safe semiconductor outputs
- ▶ Cable lengths up to 50 m possible
- ▶ PL d/category 3 according to EN ISO 13849-1



Safety switch CES-AH-C03-...



Details

Available coding options

- ▶ Unicode evaluation

LED indicator

STATE Status
DIA Diagnostics

Further information

- ▶ Dimension drawings see p. 21
- ▶ Accessories and spare parts see p. 20
- ▶ For detailed information, enter the order number for the product in the search box at www.euchner.com.

- ▶ One active face, not adjustable
- ▶ Diagnostics via two LEDs
- ▶ PL d/category 3
- ▶ Cable length up to 50 m possible
- ▶ Degree of protection IP 67
- ▶ Connection via plug connectors
- ▶ Start button connection

Ordering table

Safety switch

Series	Version	Order no./item	
CES-AH-C03-AH-... Unicode	M23 9 pin	106300 CES-AH-C03-AH-SM-106300	For detailed information, enter the order number for the product in the search box at www.euchner.com .

Actuator

Series	Design	Typ. operating distance [mm]	Order no./item	
CES-A-BRN	80 x 40	27	100251 CES-A-BRN-100251	For detailed information, enter the order number for the product in the search box at www.euchner.com .
CES-A-BPA	40 x 40	22	098775 CES-A-BPA	
CES-A-BBA	42 x 25	20	071840 CES-A-BBA	
CES-A-BCA	42 x 25 Material: PE-HD	20	088786 CES-A-BCA	

Accessories

Type	Version	
Connection material	Female plug (for self-assembly) M23 9 pin	Page 106
Fixing material	Safety screws	Page 116

Dimension drawing

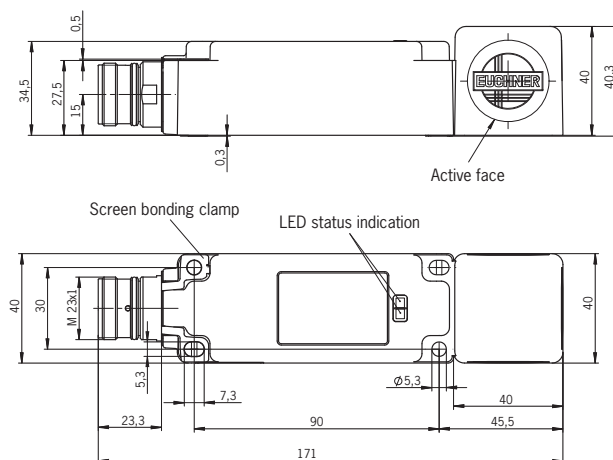

Terminal assignment

Pin	Designation	Function
1	NC	Not used
2	START	Start input
3	LA	Safety output, channel 1
4	+LA	Input for channel 1
5	+LB	Input for channel 2
6	LB	Safety output, channel 2
7	UB	Power supply DC 24 V
8	0V	Ground DC 0 V
9	-	Not used

“Developed with a focus on the essentials – a lot of safety with little effort.”

- ▶ Safety switches for separate operation
- ▶ Direct connection to IP 67 field modules for various decentral peripheral systems (depending on version)
- ▶ Two safe semiconductor outputs
- ▶ Own pulsing for short circuit detection
- ▶ Connection via plug connectors
- ▶ Cable lengths up to 200 m possible
- ▶ PL e/category 4 according to EN ISO 13849-1
- ▶ Large selection of devices
- ▶ Various guard locking devices available



CES

C01



CES

C02



CES

C04



CTP

CTP



CET

CET

Safety switch CES-AP-C01-...



- ▶ One active face, can be repositioned in five directions
- ▶ Large operating distance
- ▶ Limit-range indication
- ▶ Diagnostics via two LEDs
- ▶ Standard housing according to EN 60947-5-2
- ▶ Degree of protection IP 67

Details

Available coding options

- ▶ Unicode evaluation
- ▶ Multicode evaluation

Limit-range indication

The device detects if the actuator wanders out of the operating distance and indicates that the actuator is in the limit range by flashing the STATE LED. This allows the safety door to be readjusted in time.

Connection to IP 67 field modules

Devices with M12 plug connector, 5-pin, without monitoring output are optimized for direct connection to field modules, such as ET200pro from Siemens or comparable devices from other manufacturers.

LED indicator

STATE Status
DIA Diagnostics

Additional connections

DIA Diagnostic output (semiconductor)
RST Reset input

Further information

- ▶ Dimension drawings see p. 25
- ▶ Accessories and spare parts see p. 25
- ▶ For detailed information, enter the order number for the product in the search box at www.euchner.com.

Ordering table

Safety switch

Series	Version	Order no./item	
CES-AP-C01-AH-... Unicode	<div style="display: flex; align-items: center; gap: 10px;"> <div style="border: 1px solid black; padding: 2px;">5 pin</div> </div>	111145 CES-AP-C01-AH-SB-111145	For detailed information, enter the order number for the product in the search box at www.euchner.com .
CES-AP-C01-CH-... Multicode		111708 CES-AP-C01-CH-SB-111708	
CES-AP-C01-CH-SB Multicode		106798 CES-AP-C01-CH-SB-106798	
CES-AP-C01-CH-SA Multicode		100250 ¹⁾ CES-AP-C01-CH-SA-100250	

1) German Social Accident Insurance approval

Actuator

Series	Design	Typ. operating distance [mm]	Order no./item	
CES-A-BRN	<div style="display: flex; align-items: center; gap: 10px;"> <div style="border: 1px solid black; padding: 2px;">80 x 40</div> </div>	27	100251 CES-A-BRN-100251	For detailed information, enter the order number for the product in the search box at www.euchner.com .
CES-A-BPA	<div style="display: flex; align-items: center; gap: 10px;"> <div style="border: 1px solid black; padding: 2px;">40 x 40</div> </div>	22	098775 CES-A-BPA	
CES-A-BBA	<div style="display: flex; align-items: center; gap: 10px;"> <div style="border: 1px solid black; padding: 2px;">42 x 25</div> </div>	18	071840 CES-A-BBA	
CES-A-BCA	<div style="display: flex; align-items: center; gap: 10px;"> <div style="border: 1px solid black; padding: 2px;">42 x 25</div> </div> Material: PE-HD	18	088786 CES-A-BCA	
CES-A-BDA-18	<div style="display: flex; align-items: center; gap: 10px;"> <div style="border: 1px solid black; padding: 2px;">Ø18</div> </div>	19	156935 CES-A-BDA-18	

M12

5 pin

M12

8 pin

C01

Accessories

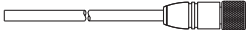
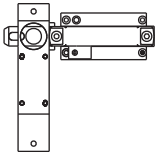
Type	Version	
Connection material	Connecting cable with plug connector 	M12 5 pin Page 97
		8 pin Page 99
Bolts	Bolts for housing design C01 	Page 108
Fixing material	Safety screws	Page 116

Dimension drawing

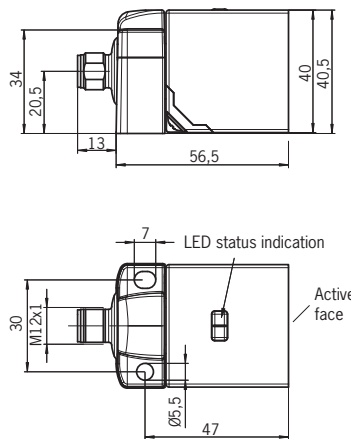

Terminal assignment

8 pin	5 pin		Designation	Function
With monitoring output	With monitoring output	Without monitoring output (pin 5 not used)		
1	–	–	–	Not used
2	1	1	UB	Power supply DC 24 V
3	2	2	OA	Safety output, channel 1
4	4	4	OB	Safety output, channel 2
5	5	–	DIA	Monitoring output (diagnostic output)
6	–	–	–	Not used
7	3	3	OV	Ground DC 0 V
8	–	–	RST	Reset input

Safety switch CES-AP-C.2-...



- ▶ **Diagnostics via two LEDs**
- ▶ **Two active faces**
- ▶ **Limit-range indication**
- ▶ **Direct mounting on aluminum profiles**
- ▶ **Large temperature range (depending on version)**
- ▶ **Reinforcement plates and safety screws included**
- ▶ **Degree of protection IP 67/IP 69/IP 69K**

Details

Available coding options

- ▶ Unicode evaluation
- ▶ Multicode evaluation

Limit-range indication

The device detects if the actuator wanders out of the operating distance and indicates that the actuator is in the limit range by flashing the STATE LED. This allows the safety door to be readjusted in time.

Connection to IP 67 field modules

Devices with M12 plug connector, 5-pin without monitoring output are optimized for direct connection to field modules, such as ET200pro from Siemens or comparable devices from other manufacturers.

Large temperature range

Devices with connecting cable and flying lead have a temperature range from -40 °C to +65 °C (with rigid cable laying).

LED indicator

STATE Status
DIA Diagnostics

Additional connections

OUT Monitoring output (semiconductor); not present on all versions.

Further information















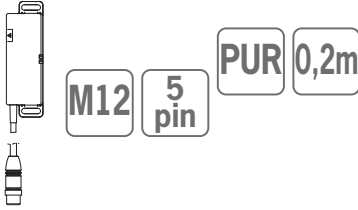

- ▶ Dimension drawings see p. 28
- ▶ Accessories and spare parts see p. 28
- ▶ For detailed information, enter the order number for the product in the search box at www.euchner.com.

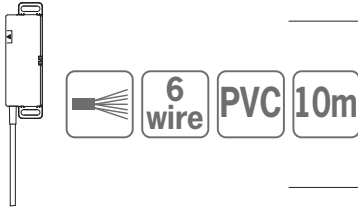
Ordering table

Safety switch









Series	Version	Door hinge ¹⁾	Order no./item		
CES-AP-C.2-AH-... Unicode	click 6 pin	With monitoring output	105295 CES-AP-CR2-AH-SF-105295	For detailed information, enter the order number for the product in the search box at www.euchner.com .	
		Without monitoring output	105294 CES-AP-CL2-AH-SF-105294		
	M12 5 pin PUR 0,2m	With monitoring output	106552 CES-AP-CR2-AH-SB-106552		
		Without monitoring output	106553 CES-AP-CL2-AH-SB-106553		
		Without monitoring output	111748 CES-AP-CR2-AH-SB-111748		
		Without monitoring output	111747 CES-AP-CL2-AH-SB-111747		
	6 wire PVC	5m	With monitoring output		105601 CES-AP-CR2-AH-L05-105601
			Without monitoring output		105603 CES-AP-CL2-AH-L05-105603
		10m	With monitoring output		106191 CES-AP-CR2-AH-L10-106191
			Without monitoring output		106192 CES-AP-CL2-AH-L10-106192
		20m	With monitoring output		106195 CES-AP-CR2-AH-L20-106195
			Without monitoring output		106196 CES-AP-CL2-AH-L20-106196

1) Applies to following alignment: connection/cable outlet pointing downward

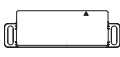

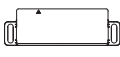
Series	Version	Door hinge ¹⁾	Order no./item		
CES-AP-C.2-CH-... Multicode		With monitoring output	 100775 CES-AP-CR2-CH-SF-100775	<p>For detailed information, enter the order number for the product in the search box at www.euchner.com.</p>	
			 104509 CES-AP-CL2-CH-SF-104509		
		With monitoring output	 106550 CES-AP-CR2-CH-SB-106550		
			 106551 CES-AP-CL2-CH-SB-106551		
		Without monitoring output	 109168 CES-AP-CR2-CH-SB-109168		
			 109167 CES-AP-CL2-CH-SB-109167		
		With monitoring output	 123922 CES-AP-CR2-CH-SB-123922		
		5m	With monitoring output		 105600 CES-AP-CR2-CH-L05-105600
					 105602 CES-AP-CL2-CH-L05-105602
		6 wire PVC 10m	With monitoring output		 106189 CES-AP-CR2-CH-L10-106189
					 106190 CES-AP-CL2-CH-L10-106190
		20m	With monitoring output		 106193 CES-AP-CR2-CH-L20-106193
		 106194 CES-AP-CL2-CH-L20-106194			

1) Applies to following alignment: connection/cable outlet pointing downward

Actuator

Series	Design	Typ. operating distance [mm]	Order no./item	
CES-A-BDN-06	 Ø6 x 26	19	104730 CES-A-BDN-06-104730	<p>For detailed information, enter the order number for the product in the search box at www.euchner.com.</p>
CES-A-BLN-...	 95 x 30	15	 100776 CES-A-BLN-R2-100776	
	 95 x 30	15	 104510 CES-A-BLN-L2-104510	
	 55 x 30 Independent of the door hinge	15	 103450 CES-A-BLN-U2-103450	

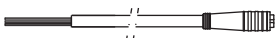
Accessories

Type	Version	
Connection material	Connecting cable with plug connector  click 6 pin	Page 94
	Connecting cable with plug connector  M12 5 pin	Page 97
Fixing material	Safety screws	Page 116

Dimension drawing

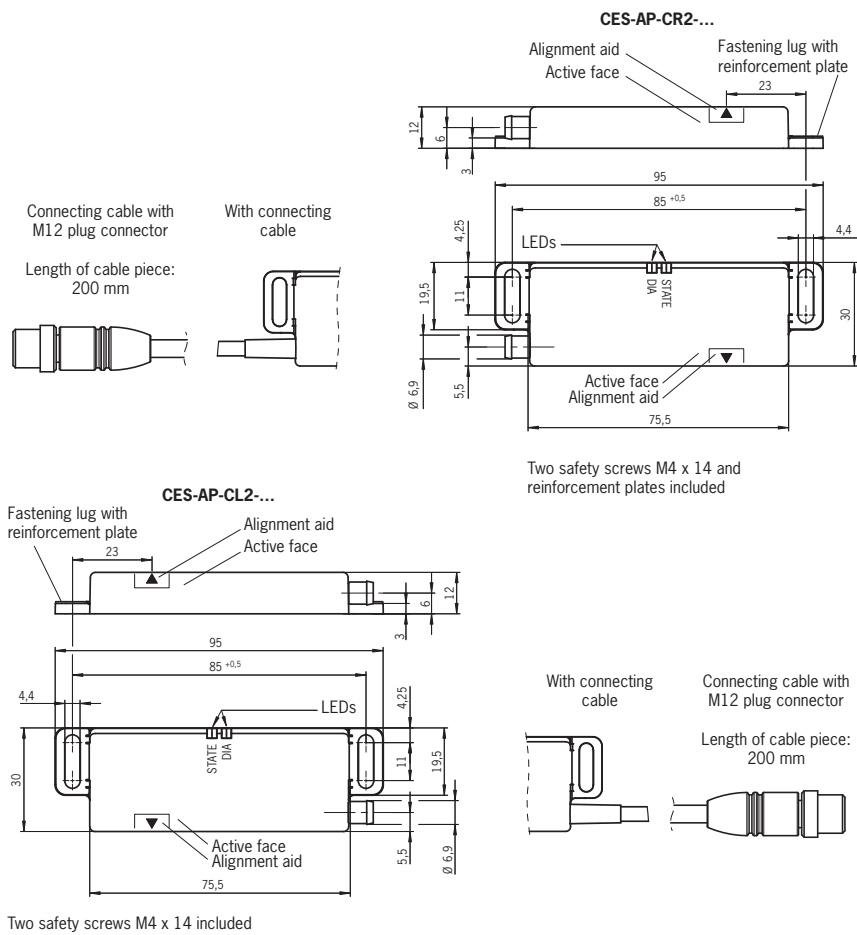



C02

Terminal assignment

6 pin With monitoring output	5 pin With monitoring output	5 pin Without monitoring output (pin 5 not used)	Designation	Function	Wire color
1	1	1	UB	Power supply DC 24 V	BN
2	2	2	OA	Safety output, channel 1	WH
3	3	3	OV	Ground DC 0 V	BU
4	4	4	OB	Safety output, channel 2	BK
5	5	-	OUT	Monitoring output (door monitoring output)	GY
6	-	-	-	Not used	PK

Safety switch CES-I-AP-.-C04-...



- ▶ **Smallest design**
- ▶ **Three active faces**
- ▶ **Diagnostics via two LEDs**
- ▶ **Limit-range indication**
- ▶ **Degree of protection IP 67**
- ▶ **ATEX protective cover (optional)**

Details

Available coding options

- ▶ Unicode evaluation
- ▶ Multicode evaluation

Limit-range indication

The device detects if the actuator wanders out of the operating distance and indicates that the actuator is in the limit range by flashing the STATE LED. This allows the safety door to be readjusted in time.

Connection to IP 67 field modules

Devices with M12 plug connector, 5-pin without monitoring output are optimized for direct connection to field modules, such as ET200pro from Siemens or comparable devices from other manufacturers.

Rubber support

A rubber support is included with each switch and actuator and is intended to prevent the accumulation of soiling in the area of the mounting holes.

LED indicator

STATE Status
DIA Diagnostics

Additional connections

OD Monitoring output (semiconductor); not present on all versions

ATEX protective cover

Housing protection AM-C-C04-EX-137528 is required for use in potentially explosive atmospheres. See accessories on p. 31.







Further information

- ▶ Dimension drawings see p. 32
- ▶ Accessories and spare parts see p. 31
- ▶ For detailed information, enter the order number for the product in the search box at www.euchner.com.



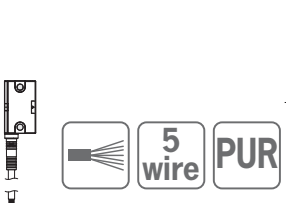

Ordering table

Safety switch







Series	Version	Order no./item	
CES-I-AP-U-C04-... Unicode	M8 4 pin Without monitoring output	115324 CES-I-AP-U-C04-SK-115324	For detailed information, enter the order number for the product in the search box at www.euchner.com .
	M12 5 pin PUR 0,1m Without monitoring output	115150 CES-I-AP-U-C04-USI-115150	
	M12 5 pin PUR 0,22m With monitoring output	116502 CES-I-AP-U-C04-USB-116502	
	M12 5 pin PUR 5m With monitoring output	116503 CES-I-AP-U-C04-U05-116503	
	5 wire PUR 10m With monitoring output	116504 CES-I-AP-U-C04-U10-116504	
	5 wire PUR 20m With monitoring output	116505 CES-I-AP-U-C04-U20-116505	

Series	Version	Order no./item	
CES-I-AP-M-C04-... Multicode	 M8 4 pin Without monitoring output	117325 CES-I-AP-M-C04-SK-117325	For detailed information, enter the order number for the product in the search box at www.euchner.com .
	 M12 5 pin PUR 0,1m Without monitoring output	117323 CES-I-AP-M-C04-USI-117323	
	 M12 5 pin PUR 0,22m With monitoring output	117324 CES-I-AP-M-C04-USB-117324	
	 M12 5 pin PUR 5m With monitoring output	117328 CES-I-AP-M-C04-U05-117328	
	 M12 5 pin PUR 10m With monitoring output	117329 CES-I-AP-M-C04-U10-117329	
	 M12 5 pin PUR 20m With monitoring output	117330 CES-I-AP-M-C04-U20-117330	

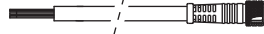
Actuator

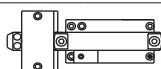
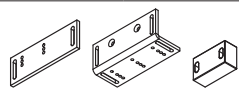
Series	Design	Typ. operating distance [mm]	Order no./item	
CES-A-BDN-06	 Ø6 x 26	19	104730 CES-A-BDN-06-104730	For detailed information, enter the order number for the product in the search box at www.euchner.com .
CES-A-BBN-C04	 42 x 25	15	115271 CES-A-BBN-C04-115271	
 CES-A-BBN-C04-EX-137527	 42 x 25	15	137527 CES-A-BBN-C04-EX-137527	

Accessories

Type	Version	
Connection material	Connecting cable with plug connector  M8 4 pin	Page 95
	Connecting cable with plug connector  M12 5 pin	Page 97
Bolts	Bolts for housing design C04 	Page 110
Fixing material	Mounting sets 	Page 114
	Safety screws 	Page 116
 Housing protection	Housing protection ATEX for switches 	Page 116

M8

4 pin

M12

5 pin



5 wire

Dimension drawing

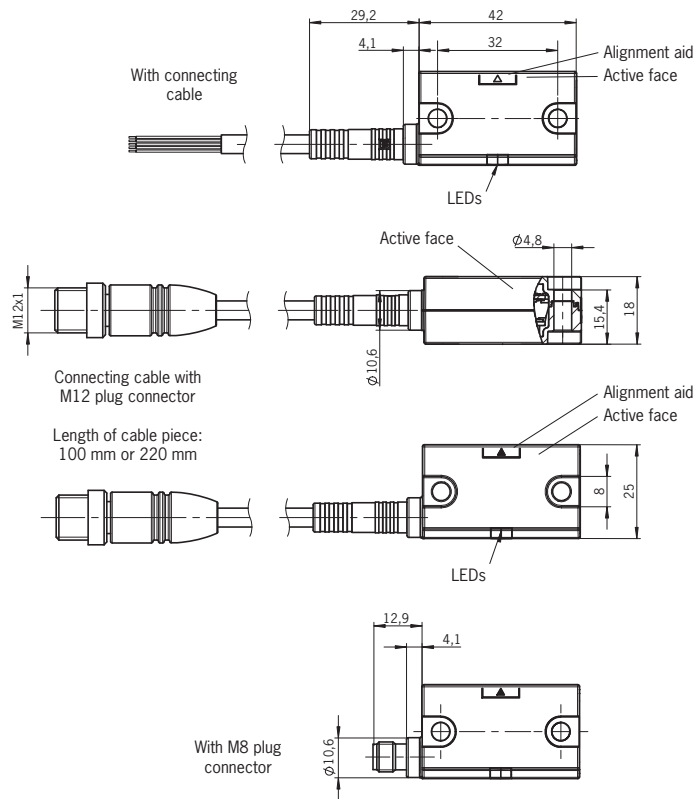

Rubber support included with switch and actuator

Terminal assignment

5 pin With monitoring output	5 wire Without monitoring output (pin 5 not used)	5 pin Without monitoring output	4 pin Without monitoring output	Designation	Function	Wire color
1	1	1	1	UB	Power supply DC 24 V	BN
2	2	2	2	FO1A	Safety output, channel 1	WH
3	3	3	3	0V	Ground DC 0 V	BU
4	4	4	4	FO1B	Safety output, channel 2	BK
5	-	-	-	OD	Monitoring output (door monitoring output)	GY

**Safety switch CTP-...-AP-...
with guard locking**



- ▶ **Safety switch with guard locking**
- ▶ **Locking force up to 3,900 N**
- ▶ **Diagnostics via three LEDs**
- ▶ **PL e/category 4**

Notice

The device is only allowed to be operated in conjunction with the actuators A-C-H....

Details

Approach direction



Head can be rotated in 90° steps

Available coding options

- ▶ Unicode evaluation
- ▶ Multicode evaluation

Guard locking types

- L1 Closed-circuit current principle**
Guard locking by spring force.
Release by applying voltage to the guard locking solenoid.
- L2 Open-circuit current principle**
Guard locking by solenoid force.
Activation of the guard locking by applying voltage to the guard locking solenoid.
- LBI BiState**
Activation input for guard locking.
This type of guard locking has a function to prevent
- persons from unintentionally locking themselves inside if the safety door is open in case of a power failure and if the machine is switched off.
- the deactivation of activated guard locking in case of a power failure.
- I1**
As for L1, but without guard lock monitoring. Guard locking for process protection only.
- I2**
As for L2, but without guard lock monitoring. Guard locking for process protection only.

Auxiliary release

Included with all versions as standard.

Escape release (optional)

Some devices have an escape release. The escape release can be extended with the aid of the support brackets supplied.

Extended version

With integrated switches (optional)

Retrofittable releases

Devices with auxiliary release can be retrofitted with various release functions (see accessories).

Connection to IP 67 field modules

Devices with plug connector SII (2 x M12, 5-pin) are optimized for direct connection to field modules, such as ET200pro from Siemens or comparable devices from other manufacturers.

LED indicator

- STATE** Status
- LOCK** Guard locking
- DIA** Diagnostics

Additional connections

- OD** Door monitoring output
- OI** Diagnostic output
- OL** Guard locking monitoring output

Further information

- ▶ Dimension drawings see p. 39
- ▶ Accessories and spare parts see p. 38
- ▶ For detailed information, enter the order number for the product in the search box at www.euchner.com.













1) German Social Accident Insurance approval pending

Ordering table





CTP-L.-AP-...-SII-... with two plug connectors M12

 Order no./item	Coding U = unicode M = multicode	Escape release	Guard locking Personnel/process protection	For wiring diagram see page 40	
CTP-L1 Closed-circuit current principle					
124468 CTP-L1-AP-U-HA-AZ-SII-124468	U				For detailed information, enter the order number for the product in the search box at www.euchner.com .
127640 CTP-L1-AP-U-HA-AE-SII-127640	U	●			
129477 CTP-L1-AP-U-HA-AZ-SII-129477	U				
129478 CTP-L1-AP-U-HA-AE-SII-129478	U	●			







CTP-..AP-...-SA-... with plug connector M12

 Order no./item	Coding U = unicode M = multicode	Escape release	Guard locking Personnel/process protection	For wiring diagram see page 40		
CTP-L1 Closed-circuit current principle						
124225 CTP-L1-AP-U-HA-AZ-SA-124225	U				For detailed information, enter the order number for the product in the search box at www.euchner.com .	
126912 CTP-L1-AP-U-HA-AE-SA-126912	U	●				
124727 CTP-L1-AP-M-HA-AZ-SA-124727	M					
CTP-L2 Open-circuit current principle						
124728 CTP-L2-AP-U-HA-AZ-SA-124728	U					
136841 CTP-L2-AP-U-HA-AE-SA-136841	U	●				
124729 CTP-L2-AP-M-HA-AZ-SA-124729	M					
CTP-LBI BiState						
127798 CTP-LBI-AP-U-HA-AZ-SA-127798	U					
CTP-I1 Process protection guard locking, closed-circuit current principle						
136595 CTP-I1-AP-U-HA-AEC-SA-136595	U	●				
CTP-I2 Process protection guard locking, open-circuit current principle						
126258 CTP-I2-AP-U-HA-AZC-SA-126258	U					







CTP...-AP-...-SA-EX-... with plug connector M12

 Order no./item	Coding U = unicode M = multicode	Escape release	Guard locking Personnel/process protection	For wiring diagram see page 40	
CTP-L1 Closed-circuit current principle					
136675 CTP-L1-AP-U-HA-AZ-SA-EX-136675	U				For detailed information, enter the order number for the product in the search box at www.euchner.com .
129512 CTP-L1-AP-U-HA-AZ-SA-EX-129512	U				











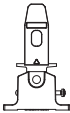

CTP...-AP-...-SH-... with plug connector M23

 Order no./item	Coding U = unicode M = multicode	Escape release	Guard locking Personnel/process protection	For wiring diagram see page 40	
CTP-L1 Closed-circuit current principle					
123364 CTP-L1-AP-U-HA-AZ-SH-123364	U				For detailed information, enter the order number for the product in the search box at www.euchner.com .
123375 CTP-L1-AP-U-HA-AE-SH-123375	U	●			
123365 CTP-L1-AP-M-HA-AZ-SH-123365	M				
123376 CTP-L1-AP-M-HA-AE-SH-123376	M	●			
CTP-L2 Open-circuit current principle					
123370 CTP-L2-AP-U-HA-AZ-SH-123370	U				
123371 CTP-L2-AP-M-HA-AZ-SH-123371	M				

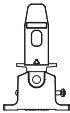
CTP...-AP-...-SH-... with plug connector M23, extended version

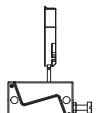

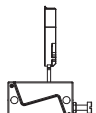







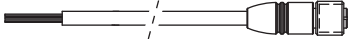

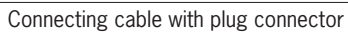

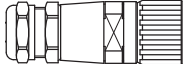
 Order no./item	Coding U = unicode M = multicode	Escape release	Controls	Guard locking Personnel/process protection	For wiring diagram see page 40	
CTP-L1 Closed-circuit current principle						
137342 CTP-L1-AP-U-HA-AEE-SH-137342	U	●	Two pushbuttons (illuminated)			For detailed information, enter the order number for the product in the search box at www.euchner.com .
156056 CTP-L1-AP-U-HA-AZE-SH-156056	U		Emergency stop, two pushbuttons (illuminated)			

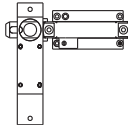
Actuator

Series	Design	Order no./item	
A-C-H...	 Straight	126015 A-C-H-G-SST-126015	For detailed information, enter the order number for the product in the search box at www.euchner.com .
	 Straight	136826 A-C-H-G-LS-EX-136826	
	 Bent, upward ¹⁾	122667 A-C-H-W-SST-122667	
	 Bent, downward ¹⁾	122668 A-C-H-W-SST-122668	
	 Hinged actuator	 ¹⁾ 122671 A-C-HRL-LS-122671	
	 Hinged actuator	 ¹⁾ 122672 A-C-HRR-LS-122672	
 Hinged actuator	 ¹⁾ 122675 A-C-HRO-LS-122675		
 Hinged actuator	 ¹⁾ 122676 A-C-HRU-LS-122676		

1) Applies to following alignment: connection/cable outlet pointing downward

Accessories

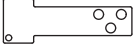
Type	Version		
Connection material	Connecting cable with plug connector 		Page 97
	Connecting cable with plug connector 		Page 99
	Connecting cable with plug connector Female plug (for self-assembly) 		Page 104/105
Bolts	Bolts for housing design CTP 		Page 111
Fixing material	Mounting plates 		Page 114
	Safety screws 		Page 116
Miscellaneous accessories	Mechanical key release 		Page 116 f.
	Release 		
	Emergency unlocking 		
	Wire front release 		
	Handle for wire front release 		
	Lockout bar 		

Dimension drawing

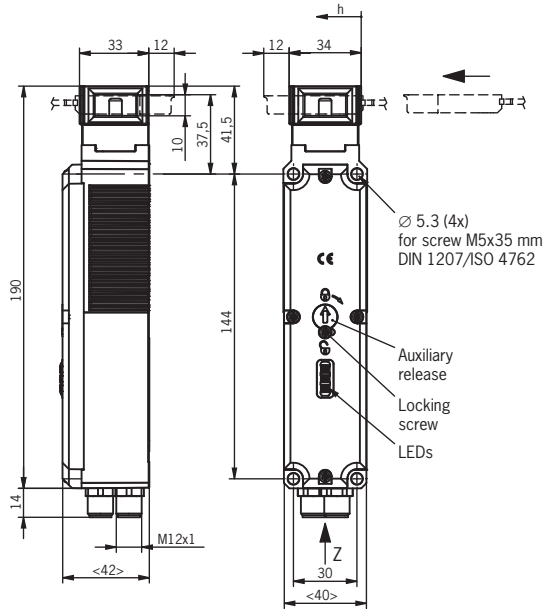

With escape release

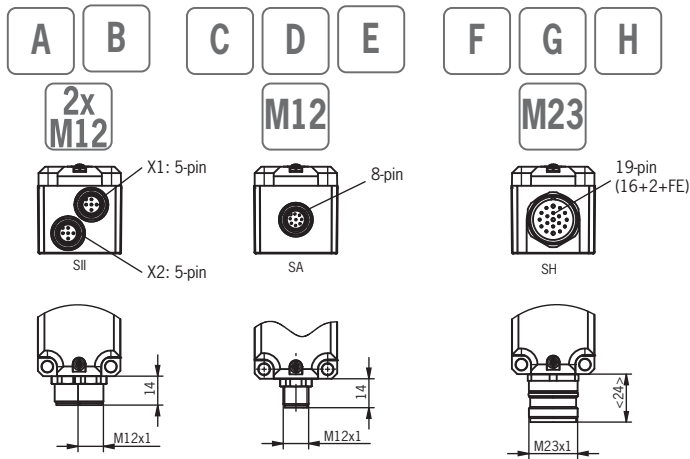
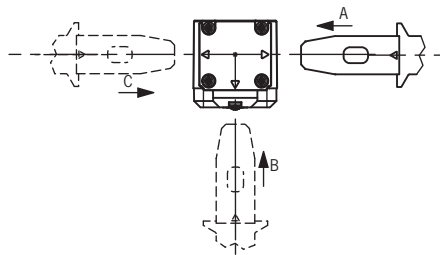
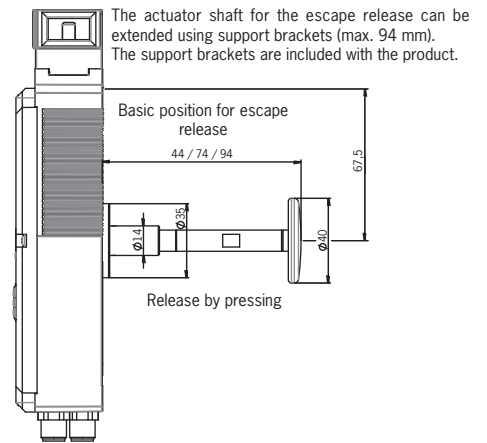

Extended version

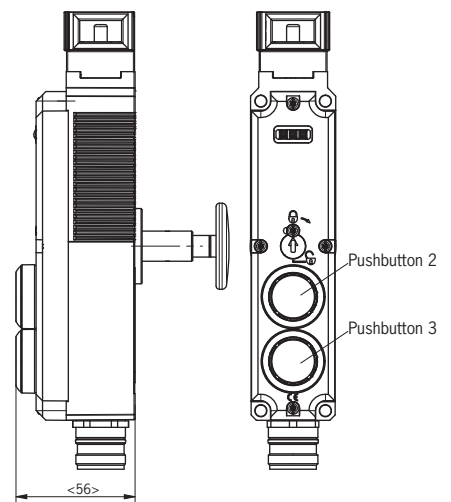



Terminal assignment

A **2x M12** **5 pin** Wiring diagram A

Pin	Designation	Function
X 1.1	U_b	Operating voltage of AP electronics, DC 24 V
X 1.2	FO1A	Safety output, channel 1
X 1.3	0 V U_b	Operating voltage of AP electronics, DC 0 V
X 1.4	FO1B	Safety output, channel 2
X 1.5	–	Not used
X 2.1	–	Not used
X 2.2	–	Not used
X 2.3	IMM	Operating voltage of guard locking solenoid, DC 0 V
X 2.4	IMP	Operating voltage of guard locking solenoid, DC 24 V
X 2.5	–	Not used

B **2x M12** **5 pin** Wiring diagram B

Pin	Designation	Function
X 1.1	U_b	Operating voltage of AP electronics, DC 24 V
X 1.2	FO1A	Safety output, channel 1
X 1.3	0 V U_b	Operating voltage of AP electronics, DC 0 V
X 1.4	FO1B	Safety output, channel 2
X 1.5	–	Not used
X 2.1	–	Not used
X 2.2	OD	Door monitoring output
X 2.3	IMM	Operating voltage of guard locking solenoid, DC 0 V
X 2.4	IMP	Operating voltage of guard locking solenoid, DC 24 V
X 2.5	–	Not used

C **M12** **8 pin** Wiring diagram C

Pin	Designation	Function
1	IMP	Operating voltage of guard locking solenoid, DC 24 V
2	U_b	Operating voltage of AP electronics, DC 24 V
3	FO1A	Safety output, channel 1
4	FO1B	Safety output, channel 2
5	OI	Diagnostic output
6	OD	Door monitoring output
7	0 V U_b	Operating voltage of AP electronics, DC 0 V
8	IMM	Operating voltage of guard locking solenoid, DC 0 V

D **M12** **8 pin** Wiring diagram D

Pin	Designation	Function
1	IMP	Control input of guard locking solenoid, DC 24 V
2	U_b	Operating voltage of AP electronics, DC 24 V
3	FO1A	Safety output, channel 1
4	FO1B	Safety output, channel 2
5	OI	Diagnostic output
6	OD	Door monitoring output
7	OL	Guard locking monitoring output
8	0 V	Operating voltage of AP electronics, DC 0 V, and control voltage of guard locking solenoid, DC 0 V

M12

8
pin

M23

19
pin

E

M12

8
pin

Wiring diagram E

Pin	Designation	Function
1	IMP	Operating voltage of guard locking solenoid, DC 24 V
2	U _B	Operating voltage of AP electronics, DC 24 V
3	F01A	Safety output, channel 1
4	F01B	Safety output, channel 2
5	OI	Diagnostic output
6	OD	Door monitoring output
7	OL	Guard locking monitoring output
8	0 V	Operating voltage of AP electronics, DC 0 V, and guard locking solenoid, DC 0 V

F

M23

19
pin

Wiring diagram F

Pin	Designation	Function
1	IMP	Operating voltage of guard locking solenoid, DC 24 V
2	–	Not used
3	–	Not used
4	F01A	Safety output, channel 1
5	F01B	Safety output, channel 2
6	U _B	Operating voltage of AP electronics, DC 24 V
7	RST	Reset input
8	OD	Door monitoring output
9	OI	Diagnostic output
10	OL	Guard locking monitoring output
11	–	Not used
12	FE	Function earth
13	–	Not used
14	–	Not used
15	–	Not used
16	–	Not used
17	–	Not used
18	IMM	Operating voltage of guard locking solenoid, DC 0 V
19	0V U _B	Operating voltage of AP electronics, DC 0 V

M23 19 pin

G M23 19 pin Wiring diagram G

Pin	Designation	Function
1	IMP	Operating voltage of guard locking solenoid, DC 24 V
2	–	Not used
3	–	Not used
4	FO1A	Safety output, channel 1
5	FO1B	Safety output, channel 2
6	U _B	Operating voltage of AP electronics, DC 24 V, and controls/indicators, DC 24 V
7	RST	Reset input
8	OD	Door monitoring output
9	OI	Diagnostic output
10	OL	Guard locking monitoring output
11	–	Not used
12	FE	Function earth
13	IMM	Operating voltage of guard locking solenoid, DC 0 V
14	–	Not used
15	S2	Pushbutton 2 (illuminated)
16	H2	LED 2
17	S3	Pushbutton 3 (illuminated)
18	H3	LED 3
19	0V U _B	Operating voltage of AP electronics, DC 0 V, and controls/indicators, DC 0 V

H M23 19 pin Wiring diagram H

Pin	Designation	Function
1	IMP	Operating voltage of guard locking solenoid, DC 24 V
2	IMM	Operating voltage of guard locking solenoid, DC 0 V
3	S1.C	Emergency stop (auxiliary contact)
4	FO1A	Safety output, channel 1
5	FO1B	Safety output, channel 2
6	U _B	Operating voltage of AP electronics, DC 24 V, and controls/indicators, DC 24 V
7	RST	Reset input
8	OD	Door monitoring output
9	OI	Diagnostic output
10	S1.A1	Emergency stop (channel A)
11	S1.A2	Emergency stop (channel A)
12	FE	Function earth
13	S1.B1	Emergency stop (channel B)
14	S1.B2	Emergency stop (channel B)
15	S2	Pushbutton 2 (illuminated)
16	H2	LED 2
17	S3	Pushbutton 3 (illuminated)
18	H3	LED 3
19	0V U _B	Operating voltage of AP electronics, DC 0 V, and controls/indicators, DC 0 V

**Safety switch CET.-AP-...
with guard locking**



- ▶ Safety switch with guard locking
- ▶ Locking force up to 6,500 N
- ▶ Metal housing
- ▶ Diagnostics via four LEDs
- ▶ Degree of protection IP 67
- ▶ Actuator guide with large freedom of movement
- ▶ Two-channel solenoid control permissible
- ▶ Connection via plug connectors

Notice

The device is only allowed to be operated in conjunction with the actuator CET-A-...

Details

Approach direction



Head can be rotated in 90° steps

Available coding options

- ▶ Unicode evaluation
- ▶ Multicode evaluation

Category according to EN ISO 13849-1

The category is dependent on the installation position:

Installation position	Category/PL
	Cat. 3 PLe
	Cat. 4 PLe

Guard locking types

- CET3 Closed-circuit current principle**
Guard locking by spring force. Release by applying voltage to the guard locking solenoid. Monitoring of the door position: The door monitoring output OUT D is set to HIGH as soon as the actuator is above the extended plunger (state: door closed, guard locking not active). The output OUT D remains set also with guard locking active.
- CET4 Open-circuit current principle**
Guard locking by applying voltage to the guard locking solenoid. Release by spring force. Monitoring of the door position: The door monitoring output OUT D is set to HIGH as soon as the actuator is above the extended plunger (state: door closed, guard locking not active). The output OUT D remains set also with guard locking active.

Teach-in input (optional)

Some devices with unicode evaluation have a teach-in input. These devices can be taught-in only if the teach-in input has the corresponding circuit. In this way the protection against tampering is additionally increased.

Auxiliary release

Included with all versions as standard.

Escape release (optional)

Some devices have an escape release (see ordering table).

Wire front release (optional)

The wire front release permits remote unlocking of the guard locking via a pull wire. Flexible routing of the pull wire permits release of the guard locking in inaccessible installation situations.

Double ramp



Versions with double ramp can be approached from two sides.



Devices with double ramp are also suitable for applications in which the switch must be "passed over." E.g. on doors that can be opened inwards and outwards. The double ramp can be retrofitted (see accessories page 118).

LED indicator

- STATE** Status
- DIA** Diagnostics
- LED 1 red** see wiring diagram
- LED 2 green** see wiring diagram

Additional connections (depending on version)







- OUT** Monitoring output (semiconductor)
- OUT D** Door monitoring output
- DIA** Diagnostic output

Further information

- ▶ Dimension drawings see p. 48
- ▶ Accessories and spare parts see p. 47
- ▶ For detailed information, enter the order number for the product in the search box at www.euchner.com.







Ordering table

CET-AP-...-SI-... with two plug connectors M12, without door monitoring output, for connection to decentralized peripheral equipment

 Order no./item	Coding U = unicode M = multicode	Ramp	Teach-in input	Feedback loop	Escape release	Wire front release (L1) ¹⁾	For wiring diagram see page 50	
CET3								
Closed-circuit current principle								
111346 CET3-AP-CRA-AH-50X-SI-111346	U							For detailed information, enter the order number for the product in the search box at www.euchner.com .
121367 CET3-AP-CRA-AH-50X-SI-C2290-121367	U					5 m		
114073 CET3-AP-CRA-AH-50F-SI-114073	U				75 mm			
157408 CET3-AP-CRA-AH-50F-SI-C2312-157408	U				105 mm			
CET4								
Open-circuit current principle								
112082 CET4-AP-CRA-AH-50X-SI-112082	U							







1) L1 = sleeve length; cable length = L1 + 1 m. Important: Handle must be ordered separately (see accessories page 116).

CET-AP-...-SI-... with two plug connectors M12, with door monitoring output

 Order no./item	Coding U = unicode M = multicode	Ramp	Teach-in input	Feedback loop	Escape release	Wire front release (L1) ¹⁾	For wiring diagram see page 50	
CET3								
Closed-circuit current principle								
124589 CET3-AP-CRA-AH-50X-SI-C2438-124589	U							For detailed information, enter the order number for the product in the search box at www.euchner.com .
124594 CET3-AP-CRA-AH-50F-SI-C2438-127594	U				75 mm			
CET4								
Open-circuit current principle								
126763 CET4-AP-CRA-AH-50X-SI-C2438-126763	U							





1) L1 = sleeve length; cable length = L1 + 1 m. Important: Handle must be ordered separately (see accessories page 116).

CET.-AP-...-SA-... with plug connector M12, with door monitoring output

 Order no./item	Coding U = unicode M = multicode	Ramp	Teach-in input	Feedback loop	Escape release	Wire front release (L1) ¹⁾	For wiring diagram see page 50		
CET3 Closed-circuit current principle									
122398 CET3-AP-CRA-AH-50X-SA-122389	U							For detailed information, enter the order number for the product in the search box at www.euchner.com .	
121579 CET3-AP-CRA-CH-50X-SA-121579	M								
124601 CET3-AP-CRA-AH-50F-SA-124601	U		75 mm						
157287 CET3-AP-CRA-CH-50F-SA-C2312-157287	M		105 mm						
122406 CET3-AP-CRA-AH-50X-SA-122406	U								
122409 CET3-AP-CRA-CH-50X-SA-122409	M								
CET4 Open-circuit current principle									
122415 CET4-AP-CRA-AH-50X-SA-122415	U								
122413 CET4-AP-CRA-CH-50X-SA-122413	M								



1) L1 = sleeve length; cable length = L1 + 1 m. Important: Handle must be ordered separately (see accessories page 116).

CET.-AP-...-SH-... with plug connector M23, with door monitoring output







 Order no./item	Coding U = unicode M = multicode	Ramp	Teach-in input	Feedback loop	Escape release	Wire front release (L1) ¹⁾	For wiring diagram see page 51	
CET3 Closed-circuit current principle								
119106 CET3-AP-CRA-AH-50F-SH-C2312-119106	U		●		105 mm			For detailed information, enter the order number for the product in the search box at www.euchner.com .

1) L1 = sleeve length; cable length = L1 + 1 m. Important: Handle must be ordered separately (see accessories page 116).

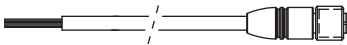
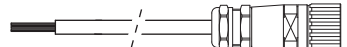
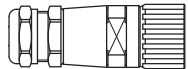
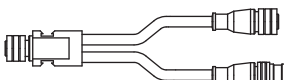
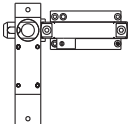
Actuator

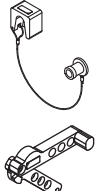
Series	Design	Order no./item	
CET-A-BWK-50X		096327 CET-A-BWK-50X	For detailed information, enter the order number for the product in the search box at www.euchner.com .

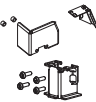
Accessories

Type	Version	
<p>Connection material</p>	<p>Connecting cable with plug connector</p>  <p>M12</p> <p>5 pin</p>	<p>Page 97 f.</p>
	<p>Connecting cable with plug connector</p>  <p>M23</p> <p>8 pin</p>	<p>Page 99</p>
	<p>Female plug (for self-assembly)</p>  <p>M23</p> <p>19 pin</p>	<p>Page 104/105</p>
	<p>Adapter for connection to IP 67 field modules For AP devices with plug connectors 2 x M12, 5-pin, with monitoring output (e.g. CET-AP with wiring diagram B) for connection to field modules with socket M12, 5-pin.</p>  <p>M12 (socket)</p> <p>5 pin</p> <p>2x M12 (plug)</p>	<p>Page 106</p>
<p>Bolts</p>	<p>Bolts for housing design CET</p> 	<p>Page 107</p>
<p>Fixing material</p>	<p>Mounting plates</p> 	<p>Page 111</p>
	<p>Safety screws</p>	<p>Page 114</p>
<p>Miscellaneous accessories</p>	<p>Lockout bar</p> 	<p>Page 116 f.</p>
	<p>Mechanical key release</p> 	
	<p>Emergency unlocking</p> 	
	<p>Cover</p> 	
	<p>Double ramp</p> 	
	<p>Handle for wire front release</p> 	

Dimension drawing

**2x
M12**

With two plug connectors M12

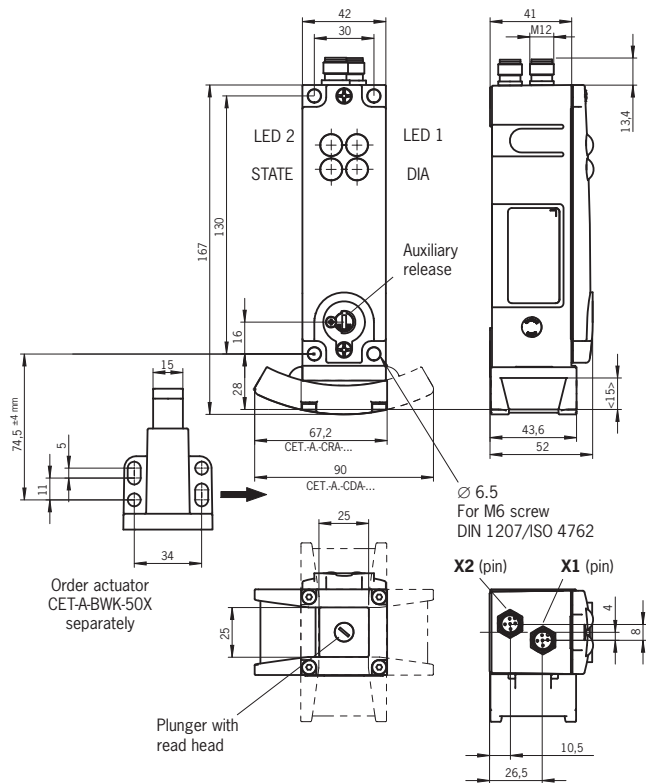

With angle connectors

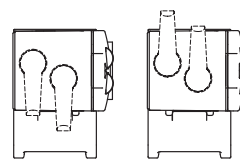

M12

With one plug connector M12

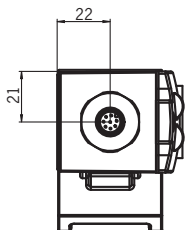

M23

With plug connector M23

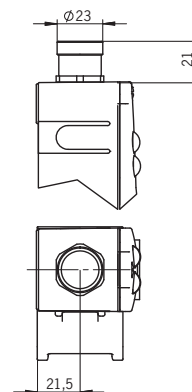

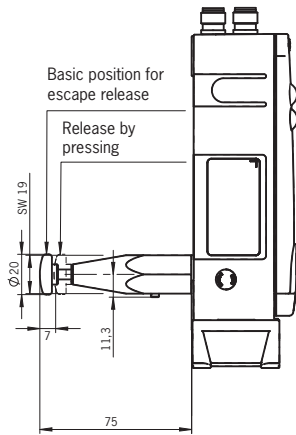
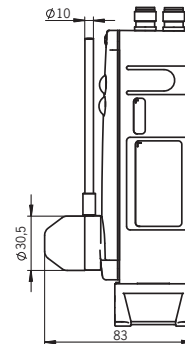
With escape release**With wire front release**

2x
M125
pin

M12

8
pin

Terminal assignment

A

B

2x
M12

Wiring diagrams A and B

Pin	Designation	Function	2x M12	
			A	B
X 1.1	U_B	Operating voltage, DC 24 V	●	●
X 1.2	OA	Safety output, channel 1	●	●
X 1.3	0 V U_B	Operating voltage, DC 0 V	●	●
X 1.4	OB	Safety output, channel 2	●	●
X 1.5	–	Not used	●	●
X 2.1	–	Not used	●	●
X 2.2	–	Not used (for connection to decentralized peripheral equipment)	●	
	OUT D	Door monitoring output		●
X 2.3	0 V U_{CM}	Operating voltage of guard locking solenoid, DC 0 V	●	●
X 2.4	U_{CM}	Operating voltage of guard locking solenoid, DC 24 V	●	●
X 2.5	–	Not used	●	●

C

D

M12

Wiring diagrams C and D

Pin	Designation	Function	M12	
			C	D
1	U_{CM}	Operating voltage of guard locking solenoid, DC 24 V	●	●
2	U_B	Operating voltage, DC 24 V	●	●
3	OA	Safety output, channel 1	●	●
4	OB	Safety output, channel 2	●	●
5	OUT	Monitoring output (guard locking active)	●	
	DIA	Monitoring output (diagnostic output)		●
6	OUT D	Door monitoring output	●	●
7	0 V U_B	Operating voltage, DC 0 V	●	●
8	0 V U_{CM}	Operating voltage of guard locking solenoid, DC 0 V	●	●

M23 **19**
pin

CET

E **M23** **Wiring diagram E**

Pin	Designation	Function
1	U _{CM}	Operating voltage of guard locking solenoid, DC 24 V
2	–	Not used
3	–	Not used
4	OA	Safety output, channel 1
5	OB	Safety output, channel 2
6	U _B	Operating voltage, DC 24 V
7	RST	Reset input
8	OUT D	Door monitoring output
9	–	Not used
10	OUT	Monitoring output (guard locking active)
11	–	Not used
12	FE	Function earth
13	J	Teach-in input
14	–	Not used
15	–	Not used
16	–	Not used
17	–	Not used
18	0V U _{CM}	Operating voltage of guard locking solenoid, DC 0 V
19	0V U _B	Operating voltage, DC 0 V

“Minimum effort for large installations with a large number of safety doors.”

- ▶ Can be connected in series with all AR devices (up to 20 devices)
- ▶ Quick connection via M12 connectors (depending on version)
- ▶ Evaluation via safety control systems or an AR evaluation unit (depending on version)
- ▶ Two safe semiconductor outputs
- ▶ Own pulsing for short circuit detection
- ▶ PL e/category 4 according to EN ISO 13849-1 for up to 20 devices
- ▶ Switch chains with cable lengths up to 200 m possible
- ▶ Large selection of devices
- ▶ Various guard locking devices available



Safety switch CES-AR-C01-...



- ▶ Up to 20 switches in series
- ▶ One active face, can be repositioned in five directions
- ▶ Diagnostics via two LEDs
- ▶ Large operating distance
- ▶ Standard housing according to EN 60947-5-2
- ▶ Limit-range indication

Details

Available coding options

- ▶ Unicode evaluation
- ▶ Multicode evaluation
- ▶ Fixcode evaluation

Limit-range indication

The device detects if the actuator wanders out of the operating distance and indicates that the actuator is in the limit range by flashing the STATE LED. This allows the safety door to be readjusted in time.

LED indicator

STATE Status
DIA Diagnostics

Additional connections

OUT Monitoring output (semiconductor)
RST Reset input

Further information

- ▶ Dimension drawings see p. 55
- ▶ Accessories and spare parts see p. 55
- ▶ For detailed information, enter the order number for the product in the search box at www.euchner.com.
- ▶ You will find information on the series connection of AR devices on page 5.

Ordering table

Safety switch

Series	Version	Order no./item	
CES-AR-C01-AH-SA Unicode		098941 CES-AR-C01-AH-SA	For detailed information, enter the order number for the product in the search box at www.euchner.com .
CES-AR-C01-CH-SA Multicode	M12 8 pin	098942 CES-AR-C01-CH-SA	
CES-AR-C01-EH-SA Fixcode (actuator CES-A-BPA included)		098582 CES-AR-C01-EH-SA	







Actuator

Series	Design	Typ. operating distance [mm]	Order no./item	
CES-A-BRN	80 x 40	27	100251 CES-A-BRN-100251	For detailed information, enter the order number for the product in the search box at www.euchner.com .
CES-A-BPA	40 x 40	22	098775 CES-A-BPA	
CES-A-BBA	42 x 25	18	071840 CES-A-BBA	
CES-A-BCA	42 x 25 Material: PE-HD	18	088786 CES-A-BCA	
CES-A-BDA-18	Ø18	19	156935 CES-A-BDA-18	

M12 8 pin

C01

Accessories

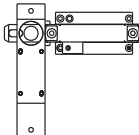
Type	Version	
Connection material	Connecting cable with plug connector 	 Page 99
	Strapping plug/Y-distributor 	 Page 101
	Passive distribution module 	 Page 102
Bolts	Bolts for housing design C01 	Page 108
Fixing material	Safety screws	Page 116

Dimension drawing

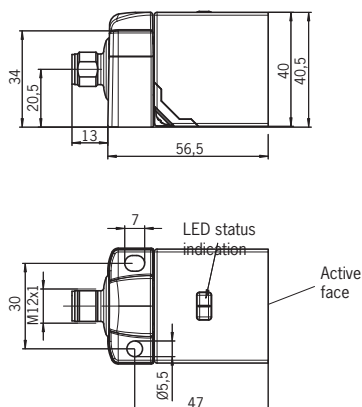

Terminal assignment

	Designation	Function
1	IB	Enable input for channel 2
2	UB	Power supply DC 24 V
3	OA	Safety output, channel 1
4	OB	Safety output, channel 2
5	OUT	Monitoring output (door monitoring output)
6	IA	Enable input for channel 1
7	OV	Ground DC 0 V
8	RST	Reset input

Safety switch CES-AR-C.2-...



- ▶ **Diagnostics via two LEDs**
- ▶ **Two active faces**
- ▶ **Limit-range indication**
- ▶ **Simple mounting on aluminum profiles**
- ▶ **Large temperature range (depending on version)**
- ▶ **Reinforcement plates and safety screws included**

Details

Available coding options

- ▶ Unicode evaluation
- ▶ Multicode evaluation

Limit-range indication

The device detects if the actuator wanders out of the operating distance and indicates that the actuator is in the limit range by flashing the STATE LED. This allows the safety door to be readjusted in time.

Large temperature range

Devices with connecting cable and flying lead have a temperature range from -30 °C to +65 °C (with rigid cable laying).

LED indicator

STATE Status
DIA Diagnostics

Additional connections

OUT Monitoring output (semiconductor)
RST Reset input

Further information















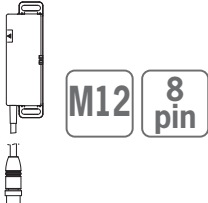

- ▶ Dimension drawings see p. 58
- ▶ Accessories and spare parts see p. 58
- ▶ For detailed information, enter the order number for the product in the search box at www.euchner.com.
- ▶ You will find information on the series connection of AR devices on page 5.

Ordering table

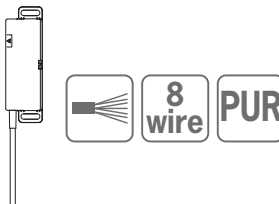
Safety switch







Series	Version	Door hinge ¹⁾	Order no./item		
CES-AR-C.2-AH-... Unicode	M8 8 pin		105751 CES-AR-CR2-AH-SG-105751	For detailed information, enter the order number for the product in the search box at www.euchner.com .	
			105753 CES-AR-CL2-AH-SG-105753		
	M12 8 pin PUR 1m		105746 CES-AR-CR2-AH-SA-105746		
			105748 CES-AR-CL2-AH-SA-105748		
	5m	8 wire PUR 10m			109046 CES-AR-CR2-AH-L05-109046
					109047 CES-AR-CL2-AH-L05-109047
		20m			109050 CES-AR-CR2-AH-L10-109050
					109051 CES-AR-CL2-AH-L10-109051
					109054 CES-AR-CR2-AH-L20-109054
					109055 CES-AR-CL2-AH-L20-109055

1) Applies to following alignment: connection/cable outlet pointing downward

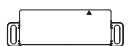

Series	Version	Door hinge ¹⁾	Order no./item			
CES-AR-C.2-CH-... Multicode			105750 CES-AR-CR2-CH-SG-105750	For detailed information, enter the order number for the product in the search box at www.euchner.com .		
			105752 CES-AR-CL2-CH-SG-105752			
		PUR 0,15m			115792 CES-AR-CR2-CH-SA-115792	
					115793 CES-AR-CL2-CH-SA-115793	
		1m			105745 CES-AR-CR2-CH-SA-105745	
					105747 CES-AR-CL2-CH-SA-105747	
		PVC 2m			112928 CES-AR-CR2-CH-SA-112928	
					112929 CES-AR-CL2-CH-SA-112929	
			5m			109044 CES-AR-CR2-CH-L05-109044
						109045 CES-AR-CL2-CH-L05-109045
			10m			109048 CES-AR-CR2-CH-L10-109048
						109049 CES-AR-CL2-CH-L10-109049
	20m				109052 CES-AR-CR2-CH-L20-109052	
			109053 CES-AR-CL2-CH-L20-109053			

1) Applies to following alignment: connection/cable outlet pointing downward

Actuator

Series	Design	Typ. operating distance [mm]	Order no./item	
CES-A-BDN-06	 Ø6 x 26	19	104730 CES-A-BDN-06-104730	For detailed information, enter the order number for the product in the search box at www.euchner.com .
CES-A-BLN-...	 95 x 30 	15	100776 CES-A-BLN-R2-100776	
	 95 x 30 	15	104510 CES-A-BLN-L2-104510	
	 55 x 30 Independent of the door hinge	15	103450 CES-A-BLN-U2-103450	

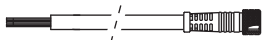
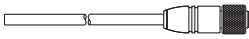
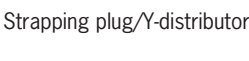
Accessories

Type	Version		
Connection material	Connecting cable with plug connector 	M8 8 pin	Page 96
	Connecting cable with plug connector 	M12 8 pin	Page 99
	Strapping plug/Y-distributor 	M12	Page 101
	Passive distribution module 	M12	Page 102
Fixing material	Safety screws	Page 116	

Dimension drawing

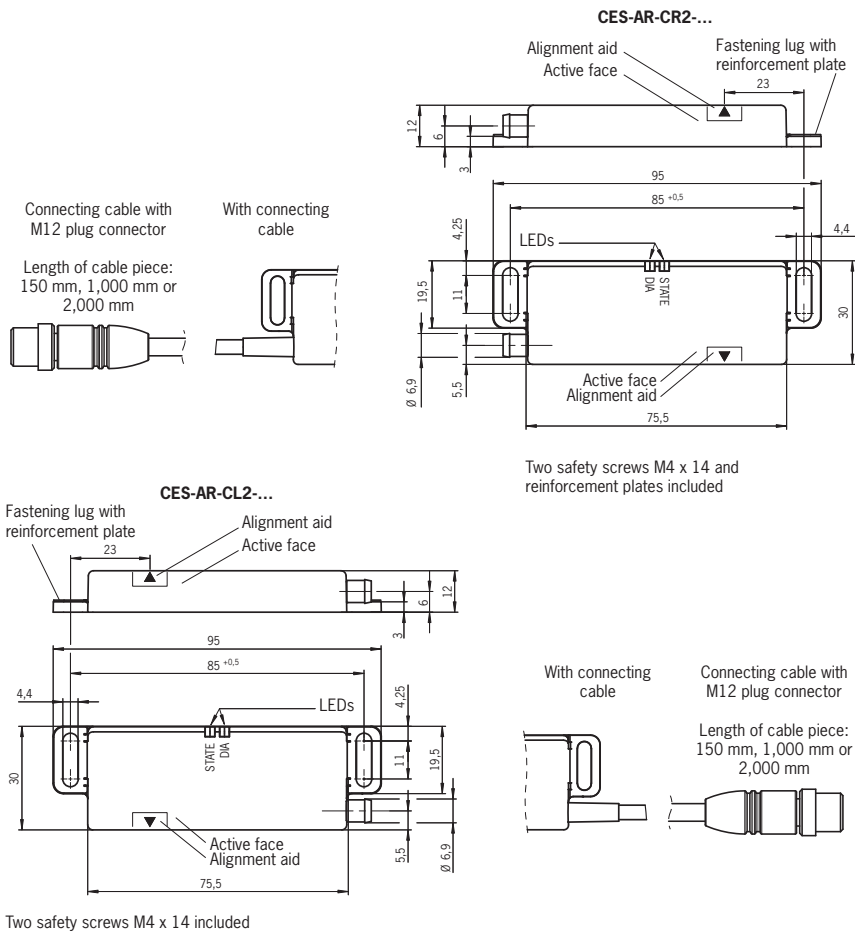

M8

8
pin

M12

8
pin



8
wire

C02

Terminal assignment

8 pin	Designation	Function	Wire color
1	IB	Enable input for channel 2	WH
2	UB	Power supply DC 24 V	BN
3	OA	Safety output, channel 1	GN
4	OB	Safety output, channel 2	YE
5	OUT	Monitoring output (door monitoring output)	GY
6	IA	Enable input for channel 1	PK
7	OV	Ground DC 0 V	BU
8	RST	Reset input	RD

Safety switch CES-I-AR-.-C04-...



- ▶ **Smallest design**
- ▶ **Three active faces**
- ▶ **Diagnostics via two LEDs**
- ▶ **Limit-range indication**
- ▶ **Rubber support for protection against soiling**
- ▶ **ATEX protective cover (optional)**

Details

Available coding options

- ▶ Unicode evaluation
- ▶ Multicode evaluation

Limit-range indication

The device detects if the actuator wanders out of the operating distance and indicates that the actuator is in the limit range by flashing the STATE LED. This allows the safety door to be readjusted in time.

Rubber support

A rubber support is included with each switch and actuator and is intended to prevent the accumulation of soiling in the area of the mounting holes.

LED indicator

STATE Status
DIA Diagnostics

ATEX protective cover

Housing protection AM-C-C04-EX-137528 is required for use in potentially explosive atmospheres. See accessories on p. 61.







Further information

- ▶ Dimension drawings see p. 62
- ▶ Accessories and spare parts see p. 61
- ▶ For detailed information, enter the order number for the product in the search box at www.euchner.com.
- ▶ You will find information on the series connection of AR devices on page 5.





Ordering table

Safety switch





Series	Version	Order no./item	
CES-I-AR-U-C04-... Unicode	M8 8 pin	119469 CES-I-AR-U-C04-SG-119469	For detailed information, enter the order number for the product in the search box at www.euchner.com .
	M12 8 pin PUR 1m	119473 CES-I-AR-U-C04-USA-119473	
	5m	119470 CES-I-AR-U-C04-U05-119470	
	8 wire PUR 10m	119471 CES-I-AR-U-C04-U10-119471	
	20m	119472 CES-I-AR-U-C04-U20-119472	

Series	Version	Order no./item	
CES-I-AR-M-C04-... Multicode	 M8 8 pin	119474 CES-I-AR-M-C04-SG-119474	For detailed information, enter the order number for the product in the search box at www.euchner.com .
	 M12 8 pin PUR 1m	119479 CES-I-AR-M-C04-USA-119479	
	 5m	119475 CES-I-AR-M-C04-U05-119475	
	 8 wire PUR 10m	119476 CES-I-AR-M-C04-U10-119476	
	 20m	119477 CES-I-AR-M-C04-U20-119477	

Actuator

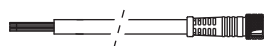
Series	Design	Typ. operating distance [mm]	Order no./item	
CES-A-BDN-06	 Ø6 x 26	19	104730 CES-A-BDN-06-104730	For detailed information, enter the order number for the product in the search box at www.euchner.com .
CES-A-BBN-C04	 42 x 25	15	115271 CES-A-BBN-C04-115271	
 CES-A-BBN-C04-EX-137527	 42 x 25	15	137527 CES-A-BBN-C04-EX-137527	

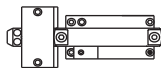
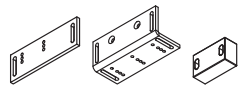
Accessories

Type	Version	
Connection material	Connecting cable with plug connector  M8 8 pin	Page 96
	Connecting cable with plug connector  M12 8 pin	Page 99
	Strapping plug/Y-distributor M12	Page 101
	Passive distribution module M12	Page 102
Bolts	Bolts for housing design C04 	Page 110
Fixing material	Mounting sets 	Page 114
	Safety screws	Page 116
 Housing protection	Housing protection ATEX for switches 	Page 116

M8

8 pin

M12

8 pin



8 wire

Dimension drawing

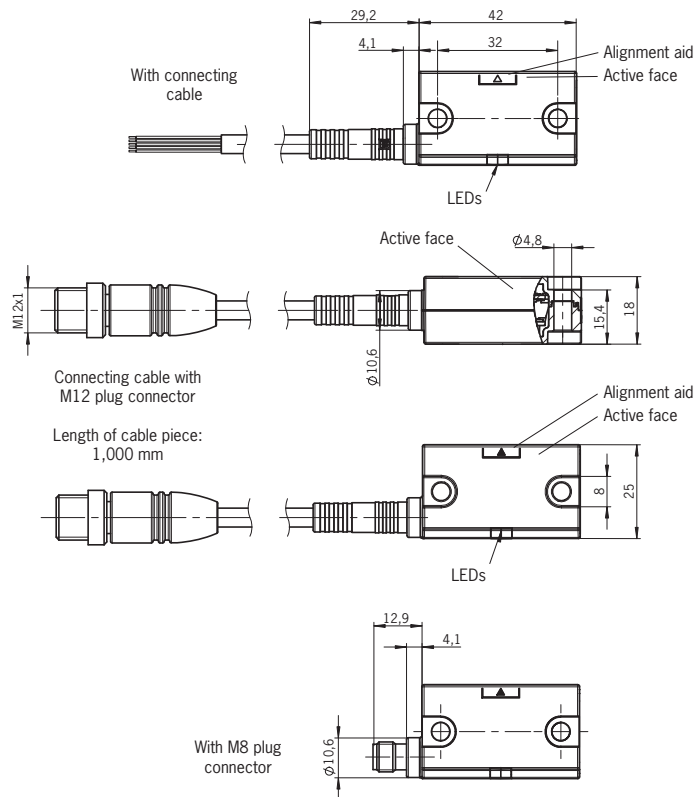

Rubber support included with switch and actuator

Terminal assignment

8 pin	Designation	Function	Wire color
1	F11B	Enable input for channel 2	WH
2	UB	Power supply DC 24 V	BN
3	FO1A	Safety output, channel 1	GN
4	FO1B	Safety output, channel 2	YE
5	OD	Monitoring output (door monitoring output)	GY
6	F11A	Enable input for channel 1	PK
7	OV	Ground DC 0 V	BU
8	RST	Reset input	RD

Safety system ESL-IH-AR-...



- ▶ Safety switch and door handle in one device
- ▶ Very simple mounting
- ▶ Robust metal housing
- ▶ Optional lock
- ▶ Diagnostics via two LEDs

Details

Available coding options

- ▶ Unicode evaluation
- ▶ Multicode evaluation

Changeover for right/left doors

The device can be adapted for doors hinged on right and left by rotating the connection. The devices are suitable only for hinged doors.

Lock (optional)



To protect against unintended machine operation, the device is available with a lock. This protects against unintentional opening of the door.

LED indicator

STATE Status
DIA Diagnostics

Further information

- ▶ Dimension drawings see p. 65
- ▶ Accessories and spare parts see p. 64
- ▶ For detailed information, enter the order number for the product in the search box at www.euchner.com.
- ▶ You will find information on the series connection of AR devices on page 5.

Ordering table

Safety switch

Series	Version	Order no./item	
ESL-IH-AR-... Unicode		115320 ESL-IH-AR-U-R30-SA-115320	For detailed information, enter the order number for the product in the search box at www.euchner.com .
		120824 ESL-IH-AR-U-R30-SA-120824	
ESL-IH-AR-... Multicode		114943 ESL-IH-AR-M-R30-SA-114943	
	-	120646 ESL-IH-AR-M-R30-SA-120646	

Accessories

Type	Version	
Connection material	Connecting cable with plug connectors 	Page 99
	Strapping plug/Y-distributor 	Page 101
	Passive distribution module 	Page 102
Fixing material	Safety screws 	Page 116

Dimension drawing

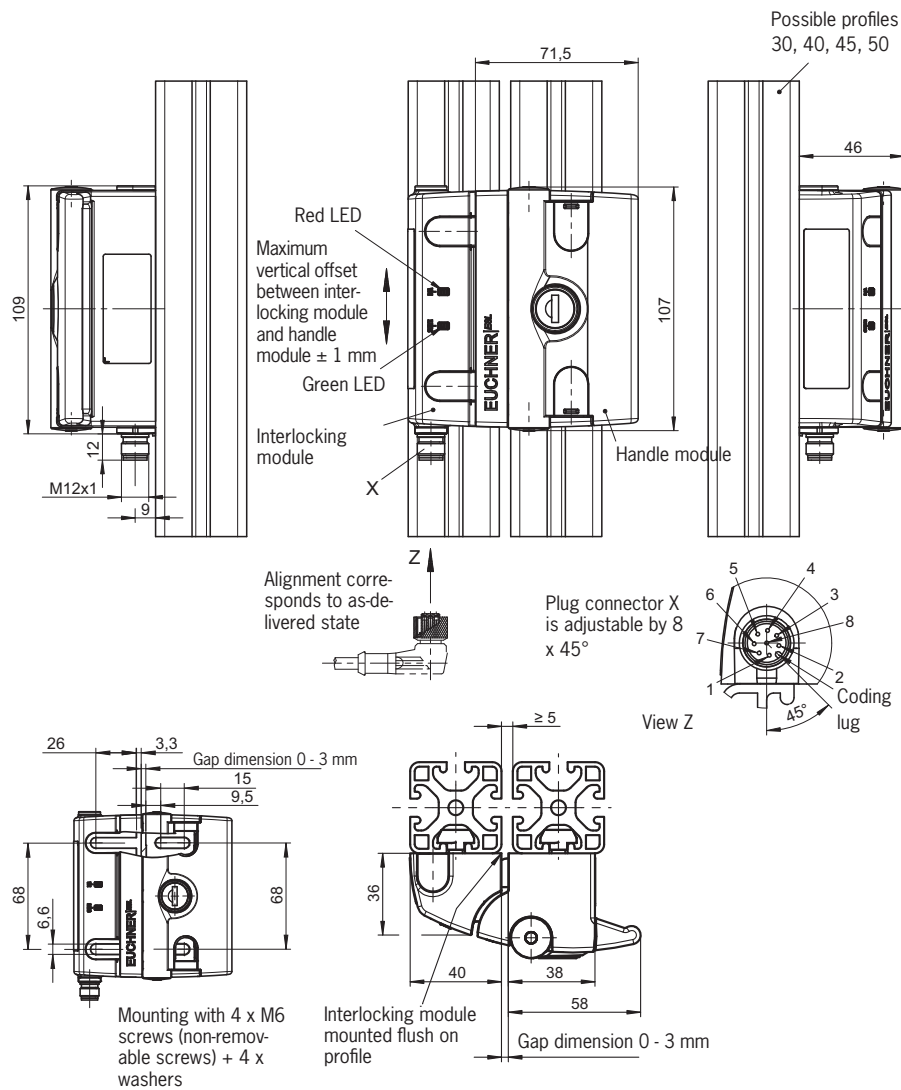

Terminal assignment

Pin	Designation	Function
1	F11B	Enable input, channel 2
2	UB	Operating voltage, 24 V DC
3	F01A	Safety output, channel 1
4	F01B	Safety output, channel 2
5	OD	Monitoring output (door monitoring output)
6	F11A	Enable input, channel 1
7	0 V UB	Operating voltage, 0 V
8	RST	Reset input

**Safety switch CEM-I2-AR.-C40-...
with guard locking for process protection**



- ▶ Safety switch with guard locking for process protection
- ▶ Locking force 600 N
- ▶ Diagnostics via four LEDs
- ▶ Adjustable adhesive force (with guard locking inactive)
- ▶ Limit range indication for transponder and anchor plate

Notice

The safety switch CEM-I2-AR.-C40-... is only allowed to be operated in conjunction with the actuator A-C40.

Details

Available coding options

- ▶ Unicode evaluation
- ▶ Multicode evaluation

Adjustable adhesive force

The adhesive force can be adjusted with the aid of a parameterization key (order no. 125481) in steps of 0 N, 30 N (default setting on delivery) and 50 N. The adhesive force is active if guard locking is inactive. The operating voltage UB must be present for this purpose.

Limit-range indication

The device detects if the actuator wanders out of the operating distance and indicates that the actuator is in the limit range by flashing the STATE

LED. This allows the safety door to be readjusted in time. The device also signals if the guard locking force is less than 400 N on switching on.

LED indicator

POWER Operating voltage
STATE Status
DIA Diagnostics
LOCK Guard locking

Further information

- ▶ Dimension drawings see p. 67
- ▶ Accessories and spare parts see p. 66
- ▶ For detailed information, enter the order number for the product in the search box at www.euchner.com.
- ▶ You will find information on the series connection of AR devices on page 5.

Ordering table

Safety switch

Series	Version	Order no./item	
CEM-I2-AR-... Unicode	 M23 19 pin	124937 CEM-I2-AR-U-C40-SH-124937	For detailed information, enter the order number for the product in the search box at www.euchner.com .
CEM-I2-AR-... Multicode		113739 CEM-I2-AR-M-C40-SH-113739	

Actuator

Series	Design	Order no./item	
A-C40		113869 A-C40-113869	For detailed information, enter the order number for the product in the search box at www.euchner.com .
Parameterization key		125481 A-TI-001-125481	

Accessories

Type	Version	
Connection material	Connecting cable with plug connector M23 19 pin	Page 104
	Female plug (for self-assembly) M23 19 pin	Page 106
Fixing material	Mounting bracket 	Page 114
	Safety screws	Page 116
Miscellaneous accessories	Lockout bar 	Page 116

Dimension drawing

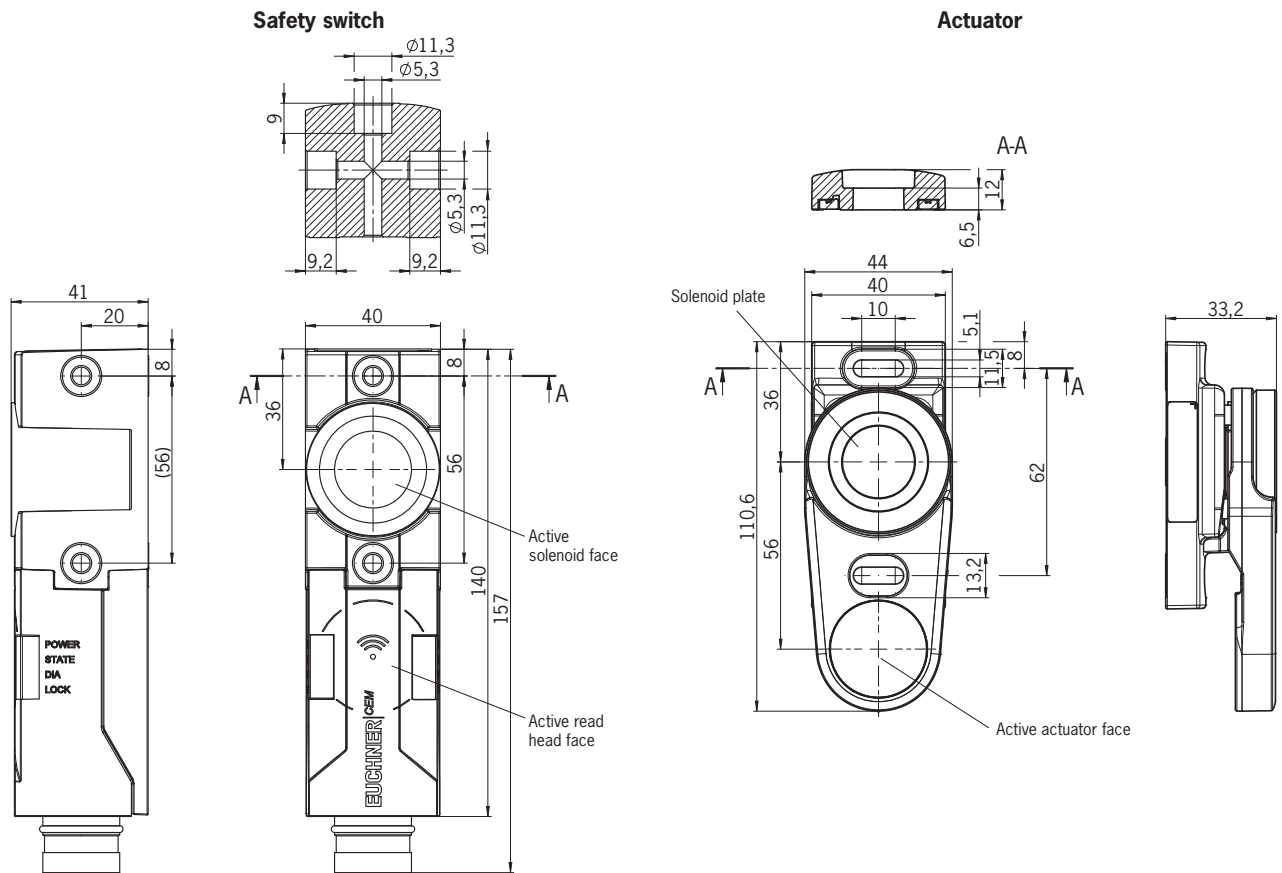

Terminal assignment

Pin	Designation	Function
1	IMP	Control voltage, guard locking solenoid, 24 V DC
2	F11A	Enable input, channel 1
3	F11B	Enable input, channel 2
4	F01A	Safety output, channel 1
5	F01B	Safety output, channel 2
6	UB	Operating voltage, 24 V DC
7	RST	Reset input
8	OT	Door monitoring output
9	OI	Diagnostic output
10	OL	Guard locking monitoring output
11	-	n.c.
12	FE	Function earth (must be connected to meet the EMC requirements)
13	-	n.c.
14	-	n.c.
15	-	n.c.
16	-	n.c.
17	-	n.c.
18	-	n.c.
19	0 V UB	Operating voltage, 0 V

**Safety switch CTP-L.-AR-...
with guard locking**



- ▶ Safety switch with guard locking
- ▶ Locking force up to 3,900 N
- ▶ Diagnostics via three LEDs

Notice

The device is only allowed to be operated in conjunction with the actuators A-C-H-....

Details

Approach direction



Head can be rotated in 90° steps

Available coding options

- ▶ Unicode evaluation
- ▶ Multicode evaluation

Guard locking types

L1 Closed-circuit current principle

Guard locking by spring force. Release by applying voltage to the guard locking solenoid.

L2 Open-circuit current principle

Guard locking by solenoid force. Activation of the guard locking by applying voltage to the guard locking solenoid.

I2 As for L2, but without guard lock monitoring.

Guard locking for process protection only.

Auxiliary release

Included with all versions as standard.

Escape release (optional)

Some devices have an escape release. The escape release can be extended with the aid of the support brackets supplied.

Retrofittable releases

Devices with auxiliary release can be retrofitted with various release functions (see accessories).

LED indicator

STATE	Status
LOCK	Guard locking
DIA	Diagnostics

Additional connections

OD	Door monitoring output
OI	Diagnostic output
OL	Guard locking monitoring output







Further information

- ▶ Dimension drawings see p. 72
- ▶ Accessories and spare parts see p. 71
- ▶ For detailed information, enter the order number for the product in the search box at www.euchner.com.
- ▶ You will find information on the series connection of AR devices on page 5.







1) German Social Accident Insurance approval pending

Ordering table











CTP-L.-AR-...-SAB-... with two plug connectors M12

 Order no./item	Coding U = unicode M = multicode	Escape release	Guard locking Personnel/process protection	For wiring diagram see page 73		
CTP-L1						
Closed-circuit current principle						
122812 CTP-L1-AR-U-HA-AZ-SAB-122812	U				For detailed information, enter the order number for the product in the search box at www.euchner.com .	
122813 CTP-L1-AR-U-HA-AE-SAB-122813	U	●				
123307 CTP-L1-AR-M-HA-AZ-SAB-123307	M					
123308 CTP-L1-AR-M-HA-AE-SAB-123308	M	●				
124067 CTP-I2-AR-M-HA-AZC-SAB-124067	M					
CTP-L2						
Open-circuit current principle						
122814 CTP-L2-AR-U-HA-AZ-SAB-122814	U					
123361 CTP-L2-AR-M-HA-AZ-SAB-123361	M					











CTP-L.-AR-...-SH-... with plug connector M23

 Order no./item	Coding U = unicode M = multicode	Escape release	Guard locking Personnel/process protection	For wiring diagram see page 73		
CTP-L1						
Closed-circuit current principle						
123362 CTP-L1-AR-U-HA-AZ-SH-123362	U				For detailed information, enter the order number for the product in the search box at www.euchner.com .	
123373 CTP-L1-AR-U-HA-AE-SH-123373	U	●				
123363 CTP-L1-AR-M-HA-AZ-SH-123363	M					
123374 CTP-L1-AR-M-HA-AE-SH-123374	M	●				
CTP-L2						
Open-circuit current principle						
123366 CTP-L2-AR-U-HA-AZ-SH-123366	U					
123369 CTP-L2-AR-M-HA-AZ-SH-123369	M					

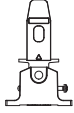
CTP-L-AR-...-SH-... plug connector M23, extended version

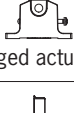

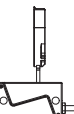







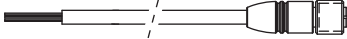

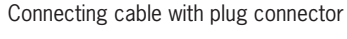

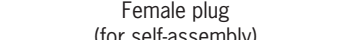

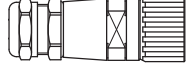

 Order no./item	Coding U = unicode M = multicode	Escape release	Controls	Guard locking Personnel/process protection	For wiring diagram see page 73	
CTP-L1 Closed-circuit current principle						
137341 CTP-L1-AR-U-HA-AZE-SH-137341	U		Two pushbuttons (illuminated)			For detailed information, enter the order number for the product in the search box at www.euchner.com .
126874 CTP-L1-AR-U-HA-AZE-SH-126874	U		Emergency stop, two pushbuttons (illuminated)			
137164 CTP-L1-AR-U-HA-AEE-SH-137164	U		Emergency stop, two pushbuttons (illuminated)			
CTP-L2 Open-circuit current principle						
137165 CTP-L2-AR-U-HA-AZE-SH-137165	U		Emergency stop, two pushbuttons (illuminated)			

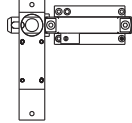
Actuator

Series	Design	Order no./item	
A-C-H-...	 Straight	126015 A-C-H-G-SST-126015	For detailed information, enter the order number for the product in the search box at www.euchner.com .
	 Bent, upward ¹⁾	122667 A-C-H-W-SST-122667	
	 Bent, downward ¹⁾	122668 A-C-H-W-SST-122668	
	 Hinged actuator	 ¹⁾ 122671 A-C-H-RL-LS-122671	
	 Hinged actuator	 ¹⁾ 122672 A-C-H-RR-LS-122672	
	 Hinged actuator	 ¹⁾ 122675 A-C-H-RO-LS-122675  ¹⁾ 122676 A-C-H-RU-LS-122676	

1) Applies to following alignment: connection/cable outlet pointing downward

Accessories

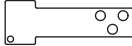
Type	Version	
Connection material	Connecting cable with plug connector 	  Page 97
	Connecting cable with plug connector 	  Page 99
	Connecting cable with plug connector 	  Page 104/105
	Female plug (for self-assembly) 	  Page 106
	Strapping plug/Y-distributor 	 Page 101
Bolts	Bolts for housing design CTP 	Page 111
Fixing material	Mounting plates 	Page 114
	Safety screws 	Page 116
Miscellaneous accessories	Mechanical key release 	Page 116 f.
	Release 	
	Emergency unlocking 	
	Wire front release 	
	Handle for wire front release 	
	Lockout bar 	

Dimension drawing

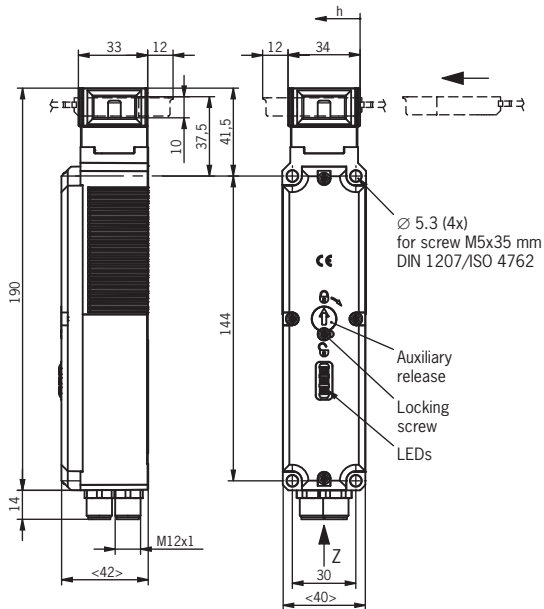

With escape release

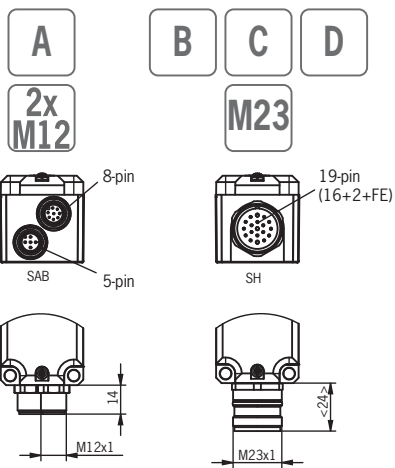
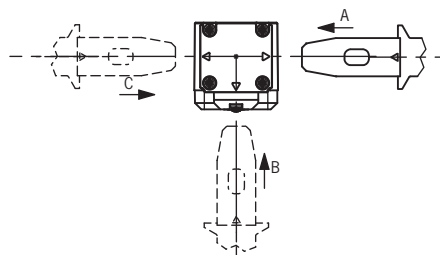
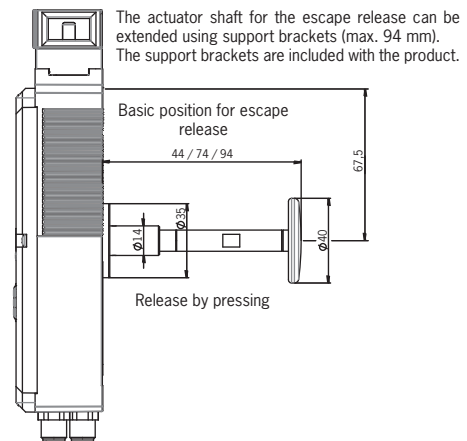

Extended version

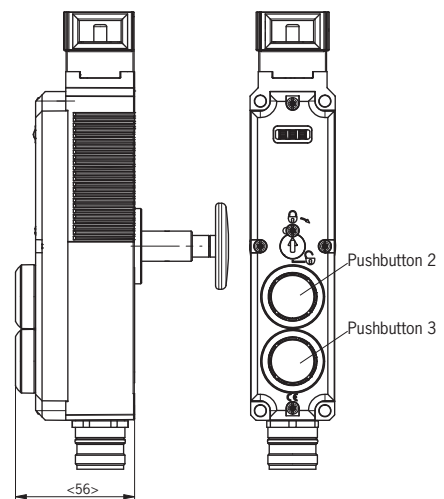

2x M12 5 pin 8 pin M23 19 pin

Terminal assignment

A **2x M12** Wiring diagram A

Pin	Designation	Function
X 1.1	FI1B	Enable input, channel 2
X 1.2	U _b	Operating voltage of AR electronics, DC 24 V
X 1.3	FO1A	Safety output, channel 1
X 1.4	FO1B	Safety output, channel 2
X 1.5	OL	Guard locking monitoring output
X 1.6	FI1A	Enable input, channel 1
X 1.7	0 V U _b	Operating voltage of AR electronics, DC 0 V
X 1.8	RST	Reset input
X 2.1	IMM	Operating voltage of guard locking solenoid, DC 0 V
X 2.2	OD	Door monitoring output
X 2.3	OI	Diagnostic output
X 2.4	IMP	Operating voltage of guard locking solenoid, DC 24 V
X 2.5	-	Not used

B **M23** Wiring diagram B

Pin	Designation	Function
1	IMP	Operating voltage of guard locking solenoid, DC 24 V
2	FI1A	Enable input, channel 1
3	FI1B	Enable input, channel 2
4	FO1A	Safety output, channel 1
5	FO1B	Safety output, channel 2
6	U _b	Operating voltage of AR electronics, DC 24 V
7	RST	Reset input
8	OD	Door monitoring output
9	OI	Diagnostic output
10	OL	Guard locking monitoring output
11	-	Not used
12	FE	Function earth (must be connected to meet the EMC requirements)
13	-	Not used
14	-	Not used
15	-	Not used
16	-	Not used
17	-	Not used
18	IMM	Operating voltage of guard locking solenoid, DC 0 V
19	0V U _b	Operating voltage of AR electronics, DC 0 V

M23 19 pin

C M23 Wiring diagram C

Pin	Designation	Function
1	IMP	Operating voltage of guard locking solenoid, DC 24 V
2	F11A	Enable input, channel 1
3	F11B	Enable input, channel 2
4	FO1A	Safety output, channel 1
5	FO1B	Safety output, channel 2
6	U _B	Operating voltage of AR electronics, DC 24 V, and controls/indicators, DC 24 V
7	RST	Reset input
8	OD	Door monitoring output
9	OI	Diagnostic output
10	OL	Guard locking monitoring output
11	–	Not used
12	FE	Function earth (must be connected to meet the EMC requirements)
13	IMM	Operating voltage of guard locking solenoid, DC 0 V
14	–	Not used
15	S2	Pushbutton 2 (illuminated)
16	H2	LED 2
17	S3	Pushbutton 3 (illuminated)
18	H3	LED 3
19	0V U _B	Operating voltage of AR electronics, DC 0 V, and controls/indicators, DC 0 V

D M23 Wiring diagram D

Pin	Designation	Function
1	IMP	Operating voltage of guard locking solenoid, DC 24 V
2	F11A	Enable input, channel 1
3	F11B	Enable input, channel 2
4	FO1A	Safety output, channel 1
5	FO1B	Safety output, channel 2
6	U _B	Operating voltage of AR electronics, DC 24 V, and controls/indicators, DC 24 V
7	RST	Reset input
8	OD	Door monitoring output
9	OI	Diagnostic output
10	S1.A1	Emergency stop (channel A)
11	S1.A2	Emergency stop (channel A)
12	FE	Function earth
13	S1.B1	Emergency stop (channel B)
14	S1.B2	Emergency stop (channel B)
15	S2	Pushbutton 2 (illuminated)
16	H2	LED 2
17	S3	Pushbutton 3 (illuminated)
18	H3	LED 3
19	0V	Operating voltage of AR electronics, DC 0 V, controls/indicators, DC 0 V, and operating voltage of guard locking solenoid, DC 0 V

Transponder-coded safety switch CET.-AR-... with guard locking



- ▶ Safety switch with guard locking
- ▶ Locking force up to 6,500 N
- ▶ Metal housing
- ▶ Diagnostics via four LEDs

Notice

The device is only allowed to be operated in conjunction with the actuator CET-A-....

Details

Approach direction



Head can be rotated in 90° steps

Available coding options

- ▶ Unicode evaluation
- ▶ Multicode evaluation

Category according to EN ISO 13849-1

The category is dependent on the installation position:

Installation position	Category/PL
	Cat. 3 PLe
	Cat. 4 PLe

Guard locking types

CET1 Closed-circuit current principle

Guard locking by spring force. Release by applying voltage to the guard locking solenoid.

CET2 Open-circuit current principle

Guard locking by solenoid force. Activation of the guard locking by applying voltage to the guard locking solenoid.

CET3 Function as for CET1-AR, but here the door position is also monitored. The door monitoring output OUT D is set to HIGH as soon as the actuator is above the extended plunger (state: door closed, guard locking not active). The output OUT D remains set also with guard locking active.

CET4 Function as for CET2-AR, but here the door position is monitored as well. The door monitoring output OUT D is set to HIGH as soon as the actuator is above the extended plunger (state: door closed, guard locking not active). The output OUT D remains set also with guard locking active.

Auxiliary release

Included with all versions as standard.

Escape release (optional)

Some devices have an escape release (see ordering table).

Wire front release (optional)

The wire front release permits remote unlocking of the guard locking via a pull wire. Flexible routing of the pull wire permits release of the guard locking in inaccessible installation situations.

Teach-in input (optional)

Some devices with unicode evaluation have a teach-in input. These devices can be taught-in only if the teach-in input has the corresponding circuit. In this way the protection against tampering is additionally increased.

Double ramp



Versions with double ramp can be approached from two sides.



Devices with double ramp are also suitable for applications in which the switch must be "passed over." E.g. on doors that can be opened inwards and outwards. The double ramp can be retrofitted (see accessories page 118).

Feedback loop (optional)

Versions with feedback loop permit monitoring of connected devices (e.g. contactors). Additionally, a start button can be integrated.

LED indicator

- STATE** Status
- DIA** Diagnostics
- LED 1 red** see wiring diagram
- LED 2 green** see wiring diagram

Additional connections













- OUT** Monitoring output (semiconductor)
- OUT D** Door monitoring output (only CET3/4)
- RST** Reset input

Further information

- ▶ Dimension drawings see p. 82
- ▶ Accessories and spare parts see p. 81
- ▶ For detailed information, enter the order number for the product in the search box at www.euchner.com.
- ▶ You will find information on the series connection of AR devices on page 5.









Ordering table

CET-AR-...-SG-... with two plug connectors M12, without door monitoring

   Order no./item	Coding U = unicode M = multicode	 Ramp	 Teach-in input	 Feedback loop	 Function earth	 Escape release	Wire front release (L1) ¹⁾	For wiring diagram see page 84		
CET1										
Closed-circuit current principle										
106275 CET1-AR-CDA-AH-50X-SG-106275	U		●						<div style="border: 1px solid black; padding: 5px; display: inline-block;">A</div>	For detailed information, enter the order number for the product in the search box at www.euchner.com .
106616 CET1-AR-CRA-AH-50A-SG-106616	U			●		75 mm				
106159 CET1-AR-CRA-AH-50F-SG-106159	U		●		75 mm					
105802 CET1-AR-CRA-AH-50S-SG-105802	U		●							
103418 CET1-AR-CRA-AH-50X-SG-103418	U		●							
113320 CET1-AR-CRA-AH-50S-SG-C2290-113320	U				●		5 m			
110241 CET1-AR-CRA-CH-50F-SG-110241	M					75 mm				
105764 CET1-AR-CRA-CH-50S-SG-105764	M		●							
105763 CET1-AR-CRA-CH-50X-SG-105763	M									
109015 CET1-AR-CRA-CH-50X-SG-C2290-109015	M				●		3 m			
109231 CET1-AR-CDA-CH-50X-SG-109231	M									
CET2										
Open-circuit current principle										
109075 CET2-AR-CRA-AH-50S-SG-109075	U			●				<div style="border: 1px solid black; padding: 5px; display: inline-block;">A</div>		
110240 CET2-AR-CRA-AH-50X-SG-110240	U		●							
109941 CET2-AR-CRA-CH-50F-SG-C2312-109941	M					105 mm				
110082 CET2-AR-CRA-CH-50X-SG-110082	M									











1) L1 = sleeve length; cable length = L1 + 1 m. Important: Handle must be ordered separately (see accessories page 116).

CET-AR-...-SG-... with two plug connectors M12, with door monitoring output

   Order no./item	Coding U = unicode M = multicode	Ramp	Teach-in input	Feedback loop	Function earth	Escape release	Wire front release (L1) ¹⁾	For wiring diagram see page 84	
CET3									
Closed-circuit current principle									
110114 CET3-AR-CRA-CH-50X-SG-C2290-110114	M				●		3 m	B	For detailed information, enter the order number for the product in the search box at www.euchner.com .
110905 CET3-AR-CRA-CH-50F-SG-C2290-110905	M				●	75 mm	3 m		
110906 CET3-AR-CRA-CH-50X-SG-110906	M				●				
110907 CET3-AR-CRA-CH-50F-SG-110907	M				●	75 mm			
109401 CET3-AR-CRA-AH-50X-SG-109401	U		●						
113139 CET3-AR-CRA-AH-50X-SG-C2290-113139	U		●				3 m		
113965 CET3-AR-CRA-AH-50F-SG-113965	U		●			75 mm			
112992 CET3-AR-CRA-CH-50S-SG-112992	M		●						
114090 CET3-AR-CDA-CH-50F-SG-114090	M								
CET4									
Open-circuit current principle									
111683 CET4-AR-CRA-AH-50X-SG-111683	U		●					B	
128193 CET4-AR-CRA-AH-50X-SG-C2290-128193	U		●				3 m		
111684 CET4-AR-CRA-CH-50X-SG-111684	M								
114650 CET4-AR-CRA-CH-50F-SG-114650	M					75 mm			
113081 CET4-AR-CRA-CH-50S-SG-113081	M			●					
114712 CET4-AR-CDA-CH-50X-SG-114712	M								
113609 CET4-AR-CRA-CH-50X-SG-C2355-113609	M						C		

1) L1 = sleeve length; cable length = L1 + 1 m. Important: Handle must be ordered separately (see accessories page 116).









CET-AR-...-SH-... plug connector M23, without door monitoring output

 Order no./item	Coding U = unicode M = multicode	Ramp	Teach-in input	Feedback loop	Function earth	Escape release	Wire front release (L1) ¹⁾	For wiring diagram see page 85	
CET1 Closed-circuit current principle									
110203 CET1-AR-CRA-AH-50X-SH-110203	U		●		●				
113022 CET1-AR-CRA-AH-50X-SH-C2290-113022	U		●		●		3 m		
113021 CET1-AR-CRA-AH-50F-SH-C2353-113021	U		●		●	105 mm	3 m		
110943 CET1-AR-CRA-AH-50F-SH-C2312-110943	U		●		●	105 mm			
110204 CET1-AR-CRA-CH-50X-SH-110204	M				●				
124104 CET1-AR-CRA-CH-50F-SH-C2312-124104	M				●	105 mm			
113255 CET1-AR-CDA-CH-50X-SH-113255	M				●				
CET2 Open-circuit current principle									
110205 CET2-AR-CRA-AH-50X-SH-110205	U		●		●				
112446 CET2-AR-CDA-AH-50X-SH-112446	U		●		●				
110206 CET2-AR-CRA-CH-50X-SH-110206	M				●				

For detailed information, enter the order number for the product in the search box at www.euchner.com.

1) L1 = sleeve length; cable length = L1 + 1 m. Important: Handle must be ordered separately (see accessories page 116).



CET-AR-...-SH-... with plug connector M23, with door monitoring output

 Order no./item	Coding U = unicode M = multicode	Ramp	Teach-in input	Feedback loop	Function earth	Escape release	Wire front release (L1) ¹⁾	For wiring diagram see page 85	
CET3 Closed-circuit current principle									
110103 CET3-AR-CRA-AH-50X-SH-110103	U		●		●				
111725 CET3-AR-CRA-AH-50F-SH-C2312-111725	U		●		●	105 mm			
113024 CET3-AR-CRA-AH-50X-SH-C2290-113024	U		●		●		3 m		
113023 CET3-AR-CRA-AH-50F-SH-C2353-113023	U		●		●	105 mm	3 m		
114088 CET3-AR-CRA-AH-50X-SH-C2290-114088	U		●		●		5 m		
113148 CET3-AR-CRA-AH-50F-SH-113148	U		●		●	75 mm			
115202 CET3-AR-CRA-AH-50X-SH-C2375-115202	U				●				
110104 CET3-AR-CRA-CH-50X-SH-110104	M				●				
114647 CET3-AR-CDA-AH-50F-SH-114647	U		●		●	75 mm			
CET4 Open-circuit current principle									
110201 CET4-AR-CRA-AH-50X-SH-110201	U		●		●				
116285 CET4-AR-CRA-AH-50F-SH-116285	U		●		●	75 mm			
110202 CET4-AR-CRA-CH-50X-SH-110202	M				●				







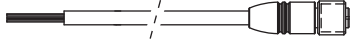
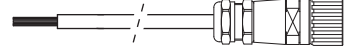
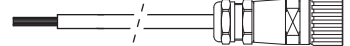
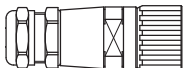
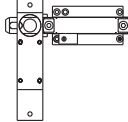

For detailed information, enter the order number for the product in the search box at www.euchner.com.

1) L1 = sleeve length; cable length = L1 + 1 m. Important: Handle must be ordered separately (see accessories page 116).

Actuator

Series	Design	Order no./item	
CET-A-BWK-50X		096327 CET-A-BWK-50X	For detailed information, enter the order number for the product in the search box at www.euchner.com .

Accessories

Type	Version	
<p>Connection material</p>	<p>Connecting cable with plug connector</p>  <p>M12</p> <p>5 pin</p>	Page 97
	<p>Connecting cable with plug connectors</p>  <p>M23</p> <p>8 pin</p>	Page 99
	<p>Connecting cable with plug connectors</p>  <p>M23</p> <p>19 pin</p>	Page 104/105
	<p>Female plug (for self-assembly)</p>  <p>M23</p> <p>19 pin</p>	Page 106
	<p>Strapping plug/Y-distributor</p> <p>M12</p>	Page 101
	<p>Passive distribution module</p> <p>M12</p>	Page 102
<p>Bolts</p>	<p>Bolts for housing design CET</p> 	Page 111
<p>Fixing material</p>	<p>Mounting plates</p> 	Page 114
	<p>Safety screws</p>	Page 116
<p>Miscellaneous accessories</p>	<p>Lockout bar</p> 	Page 116 f.
	<p>Mechanical key release</p> 	
	<p>Emergency unlocking</p> 	
	<p>Cover</p> 	
	<p>Double ramp</p> 	
	<p>Handle for wire front release</p> 	

Dimension drawing

**2x
M12**

With two plug connectors M12

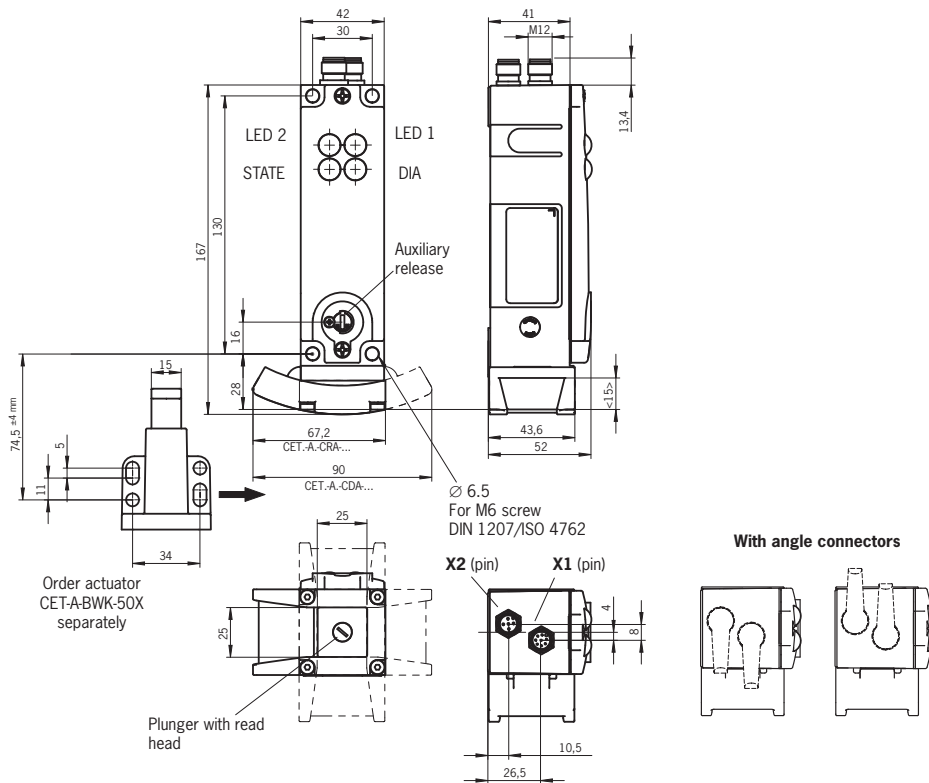

M23

With plug connector M23

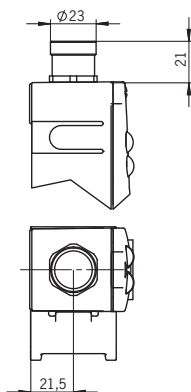

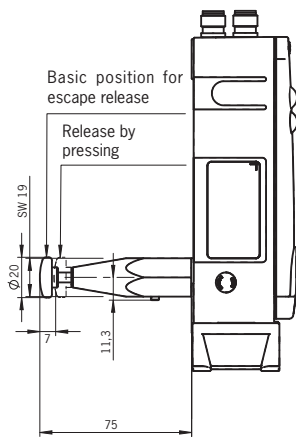
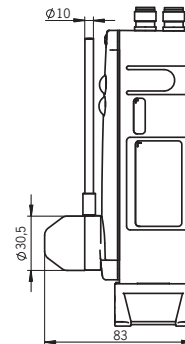
With escape release**With wire front release**

2x M12	5 pin	8 pin
-----------	----------	----------

Terminal assignment

A ... **C** Wiring diagram A to C

Pin	Designation	Function	2x M12		
			A	B	C
X 1.1	IB	Enable input for channel 2	●	●	●
X 1.2	U _B	Operating voltage of AR electronics, DC 24 V	●	●	●
X 1.3	OA	Safety output, channel 1	●	●	●
X 1.4	OB	Safety output, channel 2	●	●	●
X 1.5	OUT	Monitoring output	●	●	●
X 1.6	IA	Enable input for channel 1	●	●	●
X 1.7	0 V U _B	Operating voltage of AR electronics, DC 0 V	●	●	●
X 1.8	RST	Reset input	●	●	●
X 2.1	0 V U _{CM}	Operating voltage of guard locking solenoid, DC 0 V	●	●	●
X 2.2	LED 1	LED 1 red, freely configurable, DC 24 V	●		
	OUT D	Door monitoring output (indication on LED 2)	● ¹⁾		●
X 2.3	LED 1	LED 1 red, freely configurable, DC 24 V		●	
	LED 2	LED 2 green, freely configurable, DC 24 V	●		
	OUT	Monitoring output			●
X 2.4	U _{CM}	Operating voltage of guard locking solenoid, DC 24 V	●	●	●
X 2.5	J	Version with teach-in input	●	●	
	Y	Version with feedback loop	●	●	
	–	Version without feedback loop, without teach-in input and without function earth	●	●	●
	FE	Function earth	● ¹⁾	●	

1) Only for order no.109015

M23 19 pin

CET

D ... **E** Wiring diagrams D and E

Pin	Designation	Function	M23	
			D	E
1	U _{CM}	Operating voltage of guard locking solenoid, DC 24 V	●	●
2	IA	Enable input for channel 1	●	●
3	IB	Enable input for channel 2	●	●
4	OA	Safety output, channel 1	●	●
5	OB	Safety output, channel 2	●	●
6	U _B	Operating voltage AR electronics, DC 24 V	●	●
7	RST	Reset input	●	●
8	OUT D	Door monitoring output (only CET3-AR and CET4-AR)		●
9	-	Not used	●	●
10	OUT	Monitoring output	●	●
11	-	Not used	●	●
12	FE	Function earth	●	●
13	J	Version with teach-in input	●	●
	Y	Version with feedback loop	●	●
	-	Version without feedback loop and without teach-in input	●	●
14	-	Not used	●	●
15	LED 1	LED 1 red, freely configurable, DC 24 V	●	●
16	LED 2	LED 2 green, freely configurable, DC 24 V	●	●
17	-	Not used	●	●
18	0V U _{CM}	Operating voltage of guard locking solenoid, DC 0 V	●	●
19	0V U _B	Operating voltage of AR electronics, DC 0 V	●	●

AR evaluation unit CES-AR-AES-12

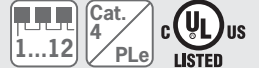

- ▶ **Central evaluation of an AR switch chain**
- ▶ **Status of each individual switch can be seen**
- ▶ **For switch chains of up to 12 devices**
- ▶ **Four individual safe relay contacts**

Details

The AR evaluation unit is used to evaluate the individual safety switches in an AR switch chain and to reliably interrupt a safety circuit. The unit has two inputs for the connection of an AR switch chain. The safety contacts are switched as a function of the input signals. Downstream parts of the safety circuit can be monitored using a feedback loop.

The switching states of the connected safety switches can be signaled by means of monitoring outputs (see table Terminal assignment p. 87). If the actuator on one of the safety switches in the switch chain is moved out of the operating distance, the AR evaluation unit opens its contacts and the corresponding monitoring output is reset. The system is designed so that failures will not result in the loss of the safety function. The occurrence of failures is detected by cyclic self-monitoring at the latest at the next demand to close the safety contacts. The system can be started either manually using a start button or automatically.

Category according to EN ISO 13849-1

Due to two redundant safety paths (relay contacts) with two internal, monitored normally open contacts per safety path, suitable for:

- ▶ Category 4/PL e according to EN ISO 13849-1
- ▶ Each safety path is independently safe.

LED indicator

STATE	Device status
DIA	Fault display
OUT	Switch chain status

Notice

The plug-in connection terminals are not included and must be ordered separately.

Further information

- ▶ Dimension drawings see p. 87
- ▶ Accessories and spare parts see p. 86
- ▶ For detailed information, enter the order number for the product in the search box at www.euchner.com.
- ▶ You will find information on the series connection of AR devices on page 5.

Ordering table

AR evaluation unit

Series	Order no./item	
CES-AR-AES-12 Unicode	098225 CES-AR-AES-12	For detailed information, enter the order number for the product in the search box at www.euchner.com .

Accessories

Type	Version	
Connection material	Connection kits for AR evaluation unit CES-AR-AES-12	Page 107

Which safety switches can be connected?

AR evaluation unit	Safety switch
098225 CES-AR-AES-12	CES-AR-C01... from V1.1.2 (see type label on the device)
	CES-AR-CR2... from V1.1.2 (see rating plate on the device)
	CES-AR-CL2... from V1.1.2 (see rating plate on the device)
	CES-I.-AR-C04 from V1.0.1 (see type label on the device)
	CET1/2-AR... from V1.1.2 (see type label on the device)
	CET3/4-AR... from V1.0.0 (see type label on the device)
	CTP-AR
	ESL-I-AR from V1.0.0

Dimension drawing

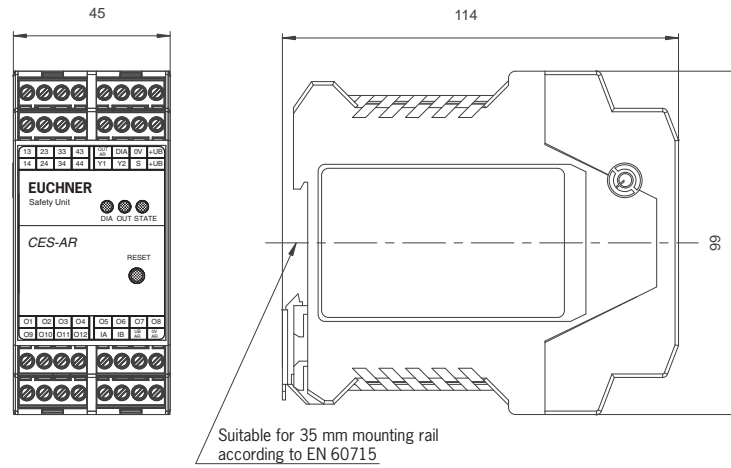

Block diagram

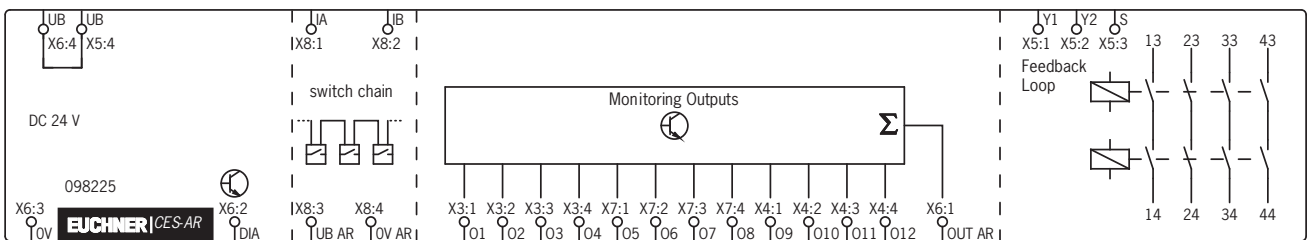

Terminal assignment

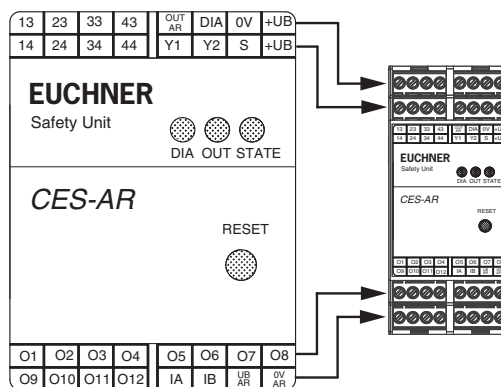

Several monitoring outputs are occupied depending on the switch type, e.g. one monitoring output for the door position and one for the guard locking status. The table below shows how many monitoring outputs the individual safety switches occupy.

Series	Number (type) of monitoring outputs
CES-AR ESL-AR	1 (door position or diagnostics)
CET1/2-AR	1 (status of guard locking)
CET3/4-AR CTP-AR	2 (first monitoring output: door position, second monitoring output: status of guard locking)

“Process protection guard locking for separate operation.”

- ▶ Safety switches for separate operation
- ▶ Magnetic guard locking for process protection
- ▶ Own pulsing for short circuit detection
- ▶ PL e/category 4 according to EN ISO 13849-1



**Safety switch CEM-I2-AY-.-C40-...
with guard locking for process protection**



- ▶ Safety switch with guard locking for process protection
- ▶ Locking force 600 N
- ▶ Diagnostics via four LEDs
- ▶ Adjustable adhesive force (with guard locking inactive)
- ▶ Limit range indication for transponder and anchor plate

Notice

The safety switch CEM-I2-AY-.-C40-... is only allowed to be operated in conjunction with the actuator A-C40.

Details

Available coding options

- ▶ Unicode evaluation

Adjustable adhesive force

The adhesive force can be adjusted with the aid of a parameterization key (order no. 125481) in steps of 0 N, 30 N (default setting on delivery) and 50 N. The adhesive force is active if guard locking is inactive. The operating voltage UB must be present for this purpose.

Limit-range indication

The device detects if the actuator wanders out of the operating distance and indicates that the actuator is in the limit range by flashing the STATE LED. This allows the safety door to be readjust-

ed in time. The device also signals if the guard locking force is less than 400 N on switching on.

LED indicator

POWER	Operating voltage
STATE	Status
DIA	Diagnostics
LOCK	Guard locking

Further information

- ▶ Dimension drawings see p. 91
- ▶ Accessories and spare parts see p. 90
- ▶ For detailed information, enter the order number for the product in the search box at www.euchner.com.

Ordering table

Safety switch

Series	Version	Order no./item	
CEM-I2-AY-... Unicode	M12 8 pin	128103 CEM-I2-AY-U-C40-SA-128103	For detailed information, enter the order number for the product in the search box at www.euchner.com .

Actuator

Series	Design	Order no./item	
A-C40		113869 A-C40-113869	For detailed information, enter the order number for the product in the search box at www.euchner.com .
Parameterization key		125481 A-TI-001-125481	

Accessories

Type	Version	
Connection material	Connecting cable with plug connector M12 8 pin	Page 99
Fixing material	Mounting bracket 	Page 114
	Safety screws	Page 116
Miscellaneous accessories	Lockout bar 	Page 116

Dimension drawing

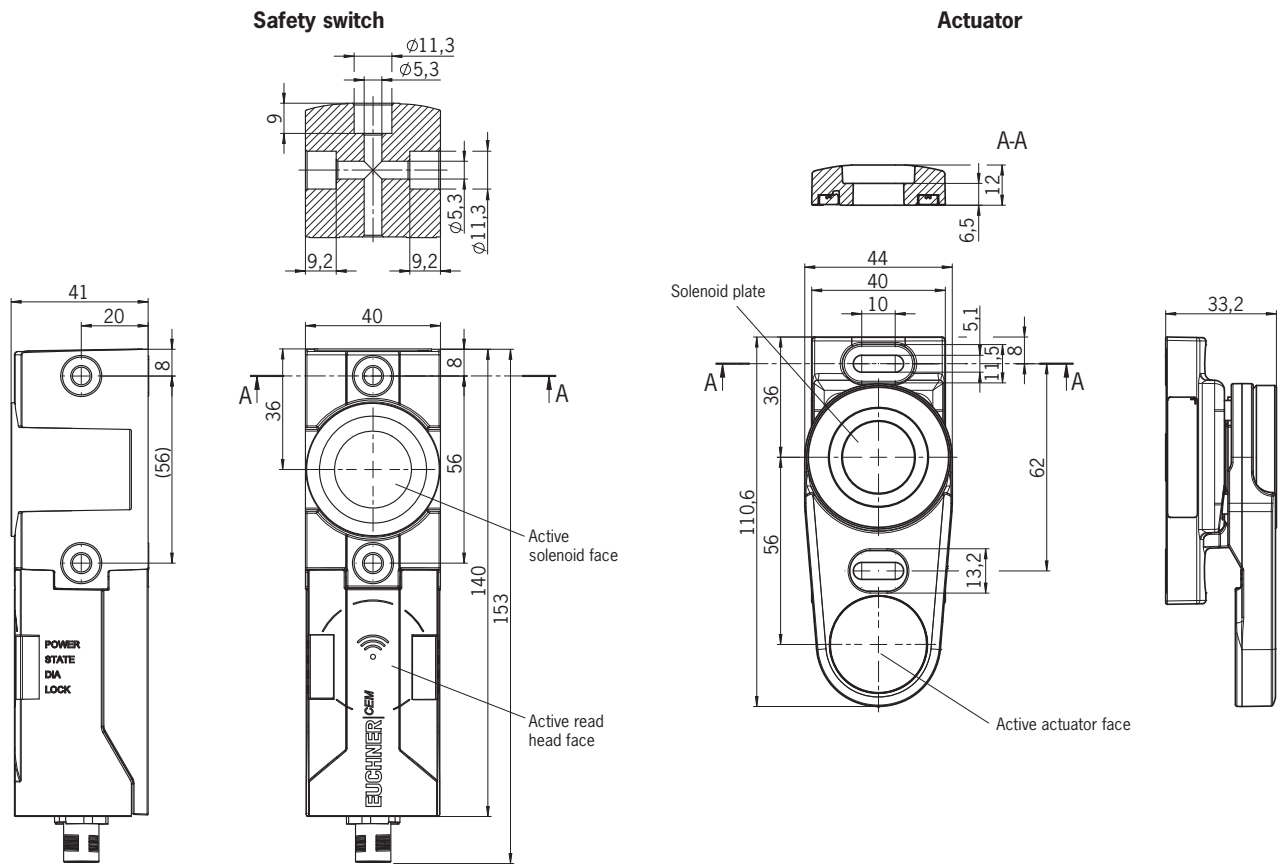

Terminal assignment

Pin	Designation	Function
1	IMP	Control voltage, guard locking solenoid, 24 V DC
2	UB	Operating voltage, 24 V DC
3	F01A	Safety output, channel 1
4	F01B	Safety output, channel 2
5	OI	Diagnostic output
6	OT	Door monitoring output
7	OL	Guard locking monitoring output
8	0 V UB	Operating voltage, 0 V

“Exploit all the advantages
– with well thought-out
original accessories from
EUCHNER.”

- ▶ Connection material – connect safely and easily; no long search for cables and plug connectors.
- ▶ Fixing material – safe and easy installation for many installation situations.
- ▶ Bolts and bolt sets – door handle and mounting plate in one.
Complete sets comprising bolt and switch as complete solution.
- ▶ Function expansions – increase the possible applications with additional functions such as releases, lockout bars, etc.

Accessories

Connection material

click 6 pin PVC

Connecting cables with snap-on catch

For the connection of:

CES-AP-C.2-...-SF

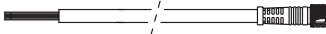

Version	Order no./item	
<div style="display: flex; align-items: center;"> <div style="margin-right: 10px;"> <p>click</p> <p>6 pin</p> <p>PVC</p> </div> <div style="text-align: center;"> <p>Connecting cable with female plug, flying lead, 6 x 0.14 mm²</p>  </div> </div>	5m	<p>103556 C-R08F06-06X014PV05,0-ES-103556</p>
	10m	<p>103557 C-R08F06-06X014PV10,0-ES-103557</p>
	15m	<p>103558 C-R08F06-06X014PV15,0-ES-103558</p>
	20m	<p>103559 C-R08F06-06X014PV20,0-ES-103559</p>
	25m	<p>103560 C-R08F06-06X014PV25,0-ES-103560</p>

For detailed information, enter the order number for the product in the search box at www.euchner.com.

Connecting cables with plug connectors

For the connection of:

CES-IAP-.C04-SK



Version		Order no./item	
<p>M8 4 pin PVC</p> <p>Connecting cable with female plug, flying lead, 4 x 0.25 mm²</p>	2m	088812 C-M08F04-04X025PV02,0-ES-088812	<p>For detailed information, enter the order number for the product in the search box at www.euchner.com.</p>
	5m	088813 C-M08F04-04X025PV05,0-ES-088813	
	10m	088814 C-M08F04-04X025PV10,0-ES-088814	
	15m	088815 C-M08F04-04X025PV15,0-ES-088815	
	25m	095035 C-M08F04-04X025PV25,0-ES-095035	
	50m	097100 C-M08F04-04X025PV50,0-ES-097100	
<p>Connecting cable with female plug, flying lead, 4 x 0.25 mm²</p>	10m	084703 C-M08F04-04X025PV10,0-ES-084703	
<p>M8 4 pin PUR</p> <p>Connecting cable with female plug, flying lead, 4 x 0.34 mm²</p>	5m	116049 C-M08F04-04X034PU05,0-ES-116049	
	10m	116050 C-M08F04-04X034PU10,0-ES-116050	
	20m	116051 C-M08F04-04X034PU20,0-ES-116051	
	50m	120241 C-M08F04-04X034PU50,0-ES-120241	

Connecting cables with plug connectors

For the connection of:

CES-AR-C.2...-SG



CES-I-AR.-C04-SG



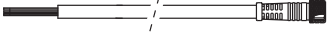
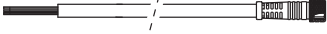



Version		Order no./item	
<div style="display: flex; flex-direction: column; align-items: center;"> <div style="border: 1px solid black; border-radius: 5px; padding: 2px; margin-bottom: 2px;">M8</div> <div style="border: 1px solid black; border-radius: 5px; padding: 2px; margin-bottom: 2px;">8 pin</div> <div style="border: 1px solid black; border-radius: 5px; padding: 2px;">PVC</div> </div>	<p>Connecting cable with female plug, flying lead, 8 x 0.14 mm²</p> 	5m	<p>110933 C-M08F08-08X014PV05,0-ES-110933</p>
		10m	<p>110934 C-M08F08-08X014PV10,0-ES-110934</p>
		15m	<p>110935 C-M08F08-08X014PV15,0-ES-110935</p>
		20m	<p>111603 C-M08F08-08X014PV20,0-ES-111603</p>
<div style="display: flex; flex-direction: column; align-items: center;"> <div style="border: 1px solid black; border-radius: 5px; padding: 2px; margin-bottom: 2px;">M8</div> <div style="border: 1px solid black; border-radius: 5px; padding: 2px; margin-bottom: 2px;">8 pin</div> <div style="border: 1px solid black; border-radius: 5px; padding: 2px;">PUR</div> </div>	<p>Connecting cable with female plug, flying lead, 8 x 0.14 mm²</p> 	5m	<p>106671 C-M08F08-08X014PU05,0-ES-106671</p>
		10m	<p>106672 C-M08F08-08X014PU10,0-ES-106672</p>
		20m	<p>106673 C-M08F08-08X014PU20,0-ES-106673</p>

For detailed information, enter the order number for the product in the search box at www.euchner.com.

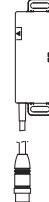

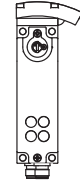
Connecting cables with plug connectors

For the connection of:

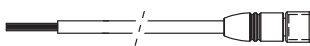
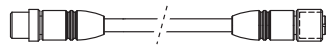
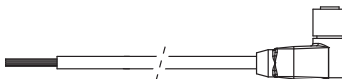
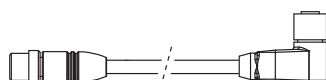
CES-AP-C01...-SB 	CES-AP-C.2...-SB 	CES-AP...-USB CES-AP...-USI 	CTP...AP...-SII CTP...AR...-SAB 	CET-AP...-SI CET-AR...-SG 
Terminal plug not aligned. Cable outlet not defined			<p>The following applies to the device installation position shown:</p> <p style="text-align: center;">Cable outlet C (left) Cable outlet A (right)</p> 	

Version	Cable outlet	Order no./item	
<p>Connecting cable with female plug, flying lead, 5 x 0.34 mm²</p> 	5m	- 100183 C-M12F05-05X034PV05,0-MA-100183	<p>For detailed information, enter the order number for the product in the search box at www.euchner.com.</p>
	10m	- 100184 C-M12F05-05X034PV10,0-MA-100184	
	20m	- 100185 C-M12F05-05X034PV20,0-MA-100185	
	50m	- 156064 C-M12F05-05X034PV50,0-MA-156064	
<p>Extension, plug connectors at both ends for connection to decentralized peripheral equipment</p> 	5m	- 100180 C-M12F05-05X034PV05,0-M12M05-100180	
	10m	- 100181 C-M12F05-05X034PV10,0-M12M05-100181	
	20m	- 100182 C-M12F05-05X034PV20,0-M12M05-100182	
<p>Connecting cable with female plug, flying lead, 5 x 0.25 mm²</p> 	10m	C 113190 C-M12F05-05X025PU10,0-MA-113190	
		A 113187 C-M12F05-05X025PU10,0-MA-113187	
<p>Extension, plug connectors at both ends for connection to decentralized peripheral equipment</p> 	10m	C 115566 C-M12F05-05X025PU10,0-M12M05-115566	
		A 115565 C-M12F05-05X025PU10,0-M12M05-115565	

M12 5 pin PUR

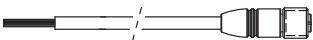
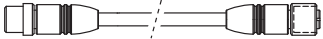
Version		Cable outlet	Order no./item	
	Connecting cable with female plug, flying lead, 5 x 0.34 mm² 	-	113620 C-M12F05-05X034PU05,0-MA-113620	For detailed information, enter the order number for the product in the search box at www.euchner.com .
	5m	-	113640 C-M12F05-05X034PU10,0-MA-113640	
	10m	-	113682 C-M12F05-05X034PU20,0-MA-113682	
	20m	-	122784 C-M12F05-05X034PU30,0-MA-113682	
30m	-	119932 C-M12F05-05X034PU05,0-M12M05-119932		
Extension, plug connectors at both ends for connection to decentralized peripheral equipment 	5m	-	119947 C-M12F05-05X034PU10,0-M12M05-119947	
	10m	-	119971 C-M12F05-05X034PU20,0-M12M05-119971	
	20m	-		

Connecting cables with plug connectors

For the connection of:

CES-AP-C01...-SA
CES-AR-C01...-SA

CES-AR-C.2...-SA

CES-AR...-USA

ESL...-AR...-SA

CEM...-AY...-SA

CTP...-AP...-SA
CTP...-AR...-SAB

CET-AP...-SA
CET-AR...-SG

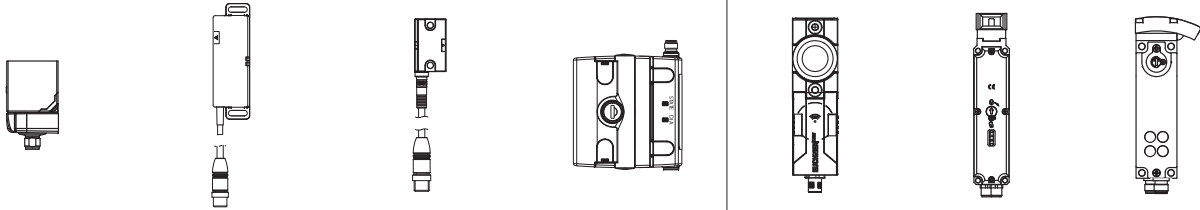

Terminal plug not aligned.
Cable outlet not defined

The following applies to the device installation position shown:



Cable outlet C (left)

Cable outlet A (right)

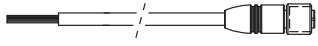
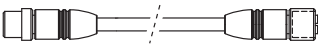
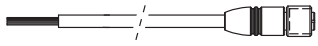

Version	Cable outlet	Order no./item	
<p>Connecting cable with female plug, flying lead, 8 x 0.25 mm²</p> 	5m	100177 C-M12F08-08X025PV05,0-MA-100177	<p>For detailed information, enter the order number for the product in the search box at www.euchner.com.</p>
	10m	100178 C-M12F08-08X025PV10,0-MA-100178	
	20m	100179 C-M12F08-08X025PV20,0-MA-100179	
	30m	115116 C-M12F08-08X025PV30,0-MA-115116	
<p>Extension, plug connectors at both ends</p> 	1m	123430 C-M12M08-08X025PV01,0-M12F08-123430	
	2m	123431 C-M12M08-08X025PV02,0-M12F08-123431	
	5m	123432 C-M12M08-08X025PV05,0-M12F08-123432	
	10m	123433 C-M12M08-08X025PV10,0-M12F08-123433	
<p>Connecting cable with female plug, flying lead, 8 x 0.25 mm²</p> 	5m	115112 C-M12F08-08X025PU05,0-MA-115112	
	10m	115113 C-M12F08-08X025PU10,0-MA-115113	
	20m	115114 C-M12F08-08X025PU20,0-MA-115114	
	30m	115257 C-M12F08-08X025PU30,0-MA-115257	

M12 8 pin PUR

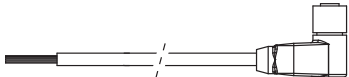
Version		Cable outlet	Order no./item	
 <p>Connecting cable with female plug, flying lead, 8 x 0.25 mm²</p> 	10m	C	113189 C-M12F08-08X025PU10,0-MA-113189	For detailed information, enter the order number for the product in the search box at www.euchner.com .
		A	113188 C-M12F08-08X025PU10,0-MA-113188	
	20m	C	120999 C-M12F08-08X025PU20,0-MA-120999	
		A	120998 C-M12F08-08X025PU20,0-MA-120998	

Strapping plug/Y-distributors

For the series connection of devices from the output family AR

For the connection of:

CES-AR-C01...-SA



CES-AR-C.2...-SA

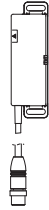

CES+AR...-USA



ESL...AR...-SA

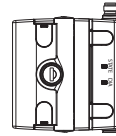





CTP-L-AR...-SAB

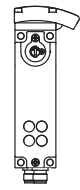

CET-AR...-SG

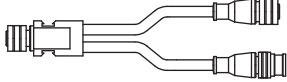

		Version	Order no.		
		Strapping plug for AR series connection with Y-distributors (male plug)	097645	For detailed information, enter the order number for the product in the search box at www.euchner.com .	
<div style="border: 1px solid black; padding: 2px; display: inline-block;">M12</div> <div style="border: 1px solid black; padding: 2px; display: inline-block;">AR</div>	 1x Y-distributor M12 with connecting cable	<div style="border: 1px solid black; padding: 2px; display: inline-block;">0,2m</div>	111696		
	<div style="border: 1px solid black; padding: 2px; display: inline-block;">8 pin</div>		<div style="border: 1px solid black; padding: 2px; display: inline-block;">1m</div>		112395
	<div style="border: 1px solid black; padding: 2px; display: inline-block;">5 pin</div>	2x Y-distributor M12			097627
	<div style="border: 1px solid black; padding: 2px; display: inline-block;">8 pin</div>	1x 			
<div style="border: 1px solid black; padding: 2px; display: inline-block;">5 pin</div>	2x Not suitable for CTP! Instead please use a Y-distributor with connecting cable (see above)				

Passive distribution module

For the series connection of devices from the output family AR

For the connection of:

CES-AR-C01...-SA

CES-AR-C.2...-SA

CES-I-AR...-USA

ESL...-AR...-SA

CTP-L-AR...-SAB

CET-AR...-SG

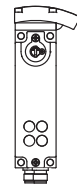
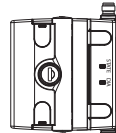

Version		Order no.	
 5x 1x	Passive distribution module	120861 AC-DP-04-SAA-120861	For detailed information, enter the order number for the product in the search box at www.euchner.com .
	Strapping plug for bypassing unused connections on the passive distribution module (male plug)	123340 AC-SP-A1-SA-123340	



Dimension drawing and connection options

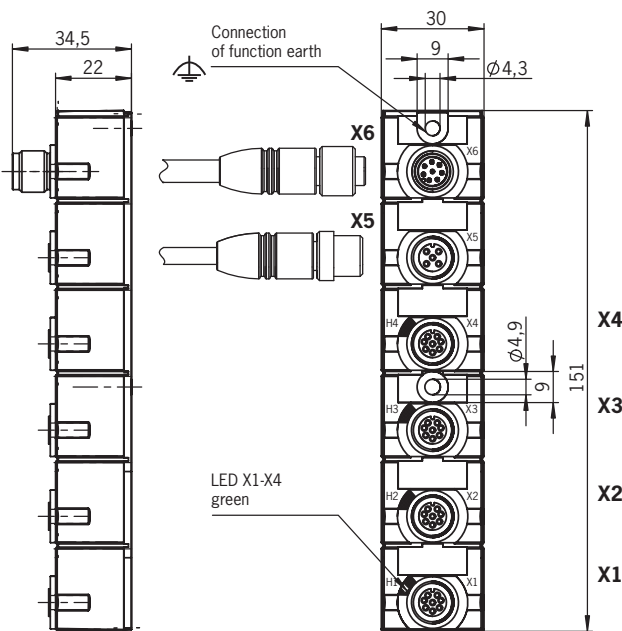

Connection	Use
X1 ... X4	- Connection of AR devices (CES-AR, CET-AR, ...) or - Bypassing using strapping plug if connection is not used or - Connection of a further passive distribution module (important: only on X1)
X5	Provision of the status signals for all AR devices connected
X6	Power supply for the AR devices and transmission of the safety signals

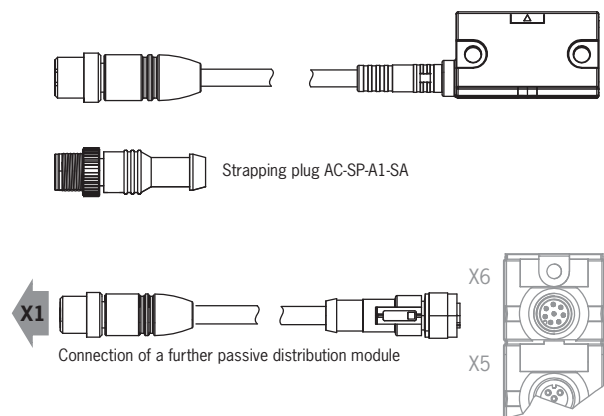

Screened connecting cables with plug connector

For the connection of:

CES-A-5

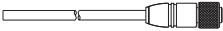

Version		Order no./item	
<div style="display: flex; align-items: center;"> <div style="margin-right: 10px;"> <p>M12</p> <p>8 pin</p> <p>PVC</p> </div> <div> <p>Connecting cable with female plug, screened ¹⁾, 8 x 0.25 mm²</p>  </div> </div>	5m	<p>077751 C-M12F08-08X025PV05,0-GA-077751</p>	<p>For detailed information, enter the order number for the product in the search box at www.euchner.com.</p>
	10m	<p>077752 C-M12F08-08X025PV10,0-GA-077752</p>	
	15m	<p>077753 C-M12F08-08X025PV15,0-GA-077753</p>	
	20m	<p>077871 C-M12F08-08X025PV20,0-GA-077871</p>	
	25m	<p>077872 C-M12F08-08X025PV25,0-GA-077872</p>	
	50m	<p>077873 C-M12F08-08X025PV50,0-GA-077873</p>	

1) The screen on the connecting cable is connected to the plug housing.

Connecting cable with straight plug connector

For the connection of:

CEM-...-AR-...-SH



CTP-...-AR-...-SH



CET-AR-...-SH



Version	Order no./item	
1,5m	092761 C-M23F19-19XDIFPU01,5-MA-092761	For detailed information, enter the order number for the product in the search box at www.euchner.com .
3m	092816 C-M23F19-19XDIFPU03,0-MA-092816	
6m	077014 C-M23F19-19XDIFPU06,0-MA-077014	
8m	077015 C-M23F19-19XDIFPU08,0-MA-077015	
10m	092898 C-M23F19-19XDIFPU08,0-MA-077015	
15m	077016 C-M23F19-19XDIFPU15,0-MA-077016	
20m	092726 C-M23F19-19XDIFPU20,0-MA-092726	
25m	092727 C-M23F19-19XDIFPU25,0-MA-092727	
30m	095993 C-M23F19-19XDIFPU30,0-MA-095993	
40m	102490 C-M23F19-19XDIFPU40,0-MA-102490	

M23
19 pin
PUR

Connecting cable with female plug, flying lead



Connecting cable with angled plug connector

For the connection of:

CEM-...-AR-...-SH



CTP-...-AR-...-SH



CET-AR-...-SH

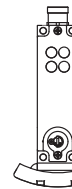

The following applies to the device installation position shown:

Cable outlet C (left)

Cable outlet A (right)

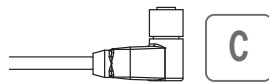

Version	Order no./item Cable outlet		
	C	A	
1,5m	092906 C-M23F19-19XDIFPU01,5- MA-092906	092907 C-M23F19-19XDIFPU01,5- MA-092907	For detailed information, enter the order number for the product in the search box at www.euchner.com .
3m	092908 C-M23F19-19XDIFPU03,0- MA-092908	092909 C-M23F19-19XDIFPU03,0- MA-092909	
6m	077018 C-M23F19-19XDIFPU06,0- MA-077018	085194 C-M23F19-19XDIFPU06,0- MA-085194	
8m	077019 C-M23F19-19XDIFPU08,0- MA-077019	085195 C-M23F19-19XDIFPU08,0- MA-085195	
10m	092901 C-M23F19-19XDIFPU10,0- MA-092901	092902 C-M23F19-19XDIFPU10,0- MA-092902	
15m	077020 C-M23F19-19XDIFPU15,0- MA-077020	085196 C-M23F19-19XDIFPU15,0- MA-085196	
20m	092910 C-M23F19-19XDIFPU20,0- MA-092910	092911 C-M23F19-19XDIFPU20,0- MA-092911	
25m	092912 C-M23F19-19XDIFPU25,0- MA-092912	092913 C-M23F19-19XDIFPU25,0- MA-092913	

M23
19 pin
PUR

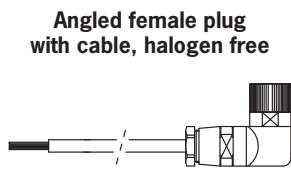

Female plug M23

For the connection of:

CES-AH-C03-...



Version	Comment	Order no.	
<p>M23</p> <p>9 pin</p> <p>Straight female plug</p>	<p>Mating connector for safety switch CES-AH-C03-...</p>	<p>106597</p>	<p>For detailed information, enter the order number for the product in the search box at www.euchner.com.</p>

Female plug M23

For the connection of:

CEM-...-AR-...-SH



CTP-...-AR-...-SH



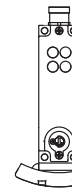

CET-AR-...-SH



Version	Comment	Order no.	
<p>M23</p> <p>19 pin</p> <p>Straight female plug (for self-assembly)</p>	<p>EF Female plug For conductor cross-section 19 x 0.75 - 1 mm²</p>	<p>074616</p>	<p>For detailed information, enter the order number for the product in the search box at www.euchner.com.</p>
	<p>EF-C1825 Female plug For conductor cross-section 16 x 0.25 - 0.5 mm² + 3 x 0.75 - 1 mm²</p>	<p>077025</p>	
<p>Angled female plug (for self-assembly)</p>	<p>WF Angled female plug For conductor cross-section 19 x 0.75 - 1 mm²</p>	<p>074617</p>	
	<p>WF-C1825 Angled female plug For conductor cross-section 16 x 0.25 - 0.5 mm² + 3 x 0.75 - 1 mm²</p>	<p>077026</p>	
<p>Replacement crimp contacts</p>	<p>For female plugs EF and WF Conductor cross-section 19 x 0.75 - 1 mm²</p>	<p>094309</p>	
	<p>For female plugs EF-C1825 and WF-C1825 Conductor cross-section 16 x 0.25 - 0.5 mm² + 3 x 0.75 - 1 mm²</p>	<p>094310</p>	







Connection kits

For connection to AR evaluation unit CES-AR-AES-12

Version	Comment	Order no.	
 Connection kits for evaluation unit CES-AR-AES-12	Plug-in screw terminals	104776 CES-EA-TC-AK08-104776	For detailed information, enter the order number for the product in the search box at www.euchner.com .
	Plug-in spring terminals	112629 CES-EA-TC-KK08-112629	







Teach-in adapter

For connection to safety switch CET

Version	Comment	Order no.	
 Teach-in adapter AC-TA-A-....	 For safety switch CET1-AR/CET3-AR	125496 AC-TA-A1-SG-125496	For detailed information, enter the order number for the product in the search box at www.euchner.com .
	 For safety switch CET2-AR/CET4-AR	125497 AC-TA-A2-SG-125497	
	 For safety switch CET1/CET3	122748 AC-TA-A1-SH-122748	
	 For safety switch CET2/CET4	122749 AC-TA-A2-SH-122749	

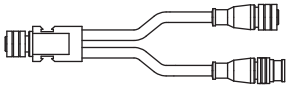
Adapter for connection to IP 67 field modules

Adapter for AP devices with plug connectors 2 x M12, 5-pin, with monitoring output (e.g. CET-AP with wiring diagram B) for connection to field modules with sockets M12, 5-pin.
The adapter makes it possible to operate the guard locking solenoid via a safe output module and to route the monitoring contact OUT D to an input module on a control system.

Designation	Version	Order no.	
  Adapter for connection to IP 67 field modules 	 (socket)   (plug)	124516 AC-YD-V0,2-SBB-124516	For detailed information, enter the order number for the product in the search box at www.euchner.com .

Bolts

C01 C05

Bolts for housing design C01/C05

Notice: The actuators are included with these bolts.

For mounting:

CES-AP-C01-...
CES-AR-C01-...



CESA-5...

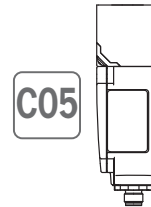

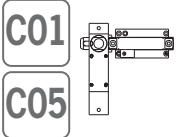
Designation	Detent mechanism/ door gap	Material	Version	Order no.	
	Bolt CES-A-C Closed position: ball detent mechanism Open position: none/ door gap: 15 mm	Steel	For doors hinged on the right or left	082220	For detailed information, enter the order number for the product in the search box at www.euchner.com .
	Bolt CES-A-C/F Closed position: ball detent mechanism Open position: detent knob/ door gap: 15 mm	Steel	Emergency release lever, for doors hinged on the right or left	098357	

Bolt sets (complete with switch)

Notice: The actuators are included with these bolts.

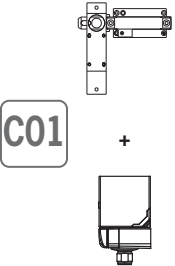
Designation	Detent mechanism/ door gap	Material	Version	Order no.	
	Closed position: ball detent mechanism/ door gap: 7 mm	Steel	Bolt with pre-assembled safety switch CES-AR-C01-AH-SA-098941 for doors hinged on the right or left	109358	For detailed information, enter the order number for the product in the search box at www.euchner.com .
	Closed position: ball detent mechanism/ door gap: 7 mm	Steel	Bolt with pre-assembled safety switch CES-AP-C01-AH-SB-111145 for doors hinged on the right or left	113986	
	Closed position: ball detent mechanism Open position: detent knob/ door gap: 15 mm	Steel	Bolt with pre-assembled safety switch CES-AR-C01-AH-SA-098941 and safety plate ¹⁾ for doors hinged on the right or left	104028	
	Closed position: ball detent mechanism Open position: detent knob/ door gap: 15 mm	Steel	Bolt with pre-assembled safety switch CES-AR-C01-AH-SA-098941 and safety plate ¹⁾ for doors hinged on the right or left, emergency release lever	105619	
	Closed position: ball detent mechanism Open position: detent knob/ door gap: 7 mm	Steel	Bolt with pre-assembled safety switch CES-AP-C01-AH-SB-111145 and safety plate ¹⁾ for doors hinged on the right or left, emergency release lever	124401	
	Closed position: ball detent mechanism Open position: detent knob/ door gap: 15 mm	Steel	Bolt with pre-assembled safety switch CES-AP-C01-AH-SB-111145 and safety plate ¹⁾ for doors hinged on the right or left, emergency release lever	116246	
	Closed position: ball detent mechanism Open position: detent knob/ door gap: 15 mm	Steel	Bolt with pre-assembled safety switch CES-AP-C01-CH-SB-111708 and safety plate ¹⁾ for doors hinged on the right or left, emergency release lever	115732	
	Closed position: ball detent mechanism/ door gap: 15 mm	Steel	Bolt with pre-assembled safety switch ¹⁾ CES-AP-C01-CH-SB-106798 for doors hinged on the right or left	110355	
	Closed position: ball detent mechanism/ door gap: 15 mm	Steel	Bolt with pre-assembled safety switch ¹⁾ CES-AP-C01-CH-SB-111708 for doors hinged on the right or left	110354	

1) The safety plate prevents the use of a padlock in closed bolt position.



Bolts for housing design C04

Notice: The actuators are **not** included with these bolts.

For mounting:

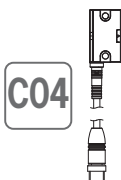
CES-IAP-.-C04-...
CES-IAR-.-C04-...



Designation	Detent mechanism/ door gap	Material	Version	Order no.	
 <p>Bolt BTC-CES04-...</p>	Closed position: spring catch Open position: none/ door gap: 7 mm	Aluminum	For doors hinged on right and left, can be locked in open position with padlocks	121646	For detailed information, enter the order number for the product in the search box at www.euchner.com .
	Closed position: spring catch Open position: detent knob/ door gap: 7 mm	Aluminum	Emergency release lever, for doors hinged on right and left, can be locked in open position with padlocks	123583	



Bolts for housing design CTP

Notice: The actuators are included with these bolts.

For mounting:

CTP-... ..



Designation	Detent mechanism/ door gap	Material	Version	Order no.	
Bolt CTP-AC	None/ door gap: 15 mm	Steel	For doors hinged on right and left, can be locked in open position with padlocks	123653	  <p>For detailed information, enter the order number for the product in the search box at www.euchner.com.</p>
Bolt CTP-ACF	Closed position: none Open position: detent knob/ door gap: 15 mm	Steel	Emergency release lever, for doors hinged on right and left, can be locked in open position with padlocks	123655	
Bolt CTP-AC-C2308	None/ door gap: 15 mm	Steel	For doors hinged on the right and left; bolt can be opened outward and inward (no end stop)	137354	
Bolt BTC-CTP-S-TH-00-X	None/ door gap: 15 mm	Die-cast aluminum	For doors hinged on right and left, can be locked in open position with padlocks	123659	
Bolt BTC-CTP-S-TH-01-F	Closed position: none Open position: detent knob/ door gap: 15 mm	Die-cast aluminum	Emergency release lever for doors hinged on the right and left; can be locked in open position with padlocks	123660	
Bolt CTP-GFK	None/ door gap: 7 mm	Plastic	For doors hinged on right and left; can be locked in open position with padlocks	123657	
Bolt CTP-GFK-F	Closed position: none Open position: detent knob/ door gap: 7 mm	Plastic	Emergency release lever, for doors hinged on right and left; can be locked in open position with padlocks	123658	
Switch bracket	–	Plastic	For safety switch CTP	096613	



Bolts for housing design CET

Notice: - Actuators are **not** included with these bolts.
 - Cover (protection against tampering) for CET actuators included.

For mounting:

CET.-A.-...

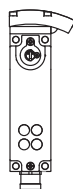





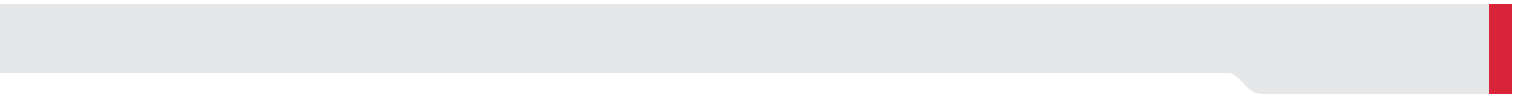



Designation	Detent mechanism/ door gap	Material	Version	Order no.	
Bolt CET-A-C	None/ door gap: 15 mm	Steel	For doors hinged on the right or left	104309	For detailed information, enter the order number for the product in the search box at www.euchner.com .
Bolt CET-A-C/F	Closed position: none Open position: detent knob/ door gap: 15 mm	Steel	For doors hinged on the right or left, for CET with escape release	106172	
Bolt CET-A-C/F-C2282	Closed position: none Open position: detent knob/ door gap: 15 mm	Steel, guide strip made of stainless steel	For doors hinged on the right or left, for CET with escape release	106350	
Bolt CET-A-C-C2308	None/ door gap: 15 mm	Steel	For doors hinged on the right or left. Bolt can be opened outward and inward (no end stop).	109672	



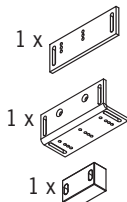





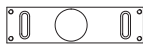

Fixing material

Mounting sets/mounting plates

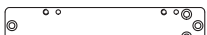
Series	Use	Order no./item	
Mounting set AM-SET-PP 	For safety switch and actuator design C04 Set comprising: 2 x mounting plates	119690 AM-SET-PP-119690	<p>For detailed information, enter the order number for the product in the search box at www.euchner.com.</p>
Mounting set AM-SET-PPB 	For safety switch and actuator design C04 Set comprising: 1 x mounting plate 1 x angle mounting plate 1 x spacer	119694 AM-SET-PPB-119694	
Mounting bracket AM-B-126230 	For actuator CEM-...-C40	126230 AM-B-126230	
Mounting bracket AM-B-126231 	For safety switch CEM-...-C40	126231 AM-B-126231	
Angle mounting plate EMP-SB 	For safety switch CTP	093456 EMP-SB	
Mounting plate EMP-B2 	For actuator CTP	093458 EMP-B2	
Mounting plate EMP-B1 	For actuator CTP and actuator CET	093457 EMP-B1	
Mounting plate AM-P 	For safety switch CTP	126026 AM-P-126026	

Series	Use	Order no./item	
Mounting plate EMP-L-CET 	For safety switch CET	106695 EMP-L-CET	For detailed information, enter the order number for the product in the search box at www.euchner.com .
Mounting plate EMP-B-CET 	For actuator CET	106694 EMP-B-CET	
Mounting plate EMP-B1 	For actuator CTP and actuator CET	093457 EMP-B1	
Mounting plate AM-P 	For safety switch CET	126399 AM-P-126399	
Mounting plate AM-P 	For actuator CET	126400 AM-P-126400	
Mounting plate with handle 	Can be combined with mounting plates AM-P-126399 and AM-P-126400	126398 AM-P-126398	







CET













Miscellaneous accessories

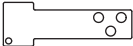



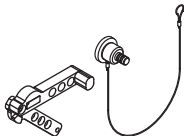

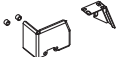
Safety screws

Fixing material/screw size	Version/usage	Packaging unit [qty.]	Order no.
Safety screws, stainless steel M4 x 14 (small head)	Actuators CES-A-BBA, CES-A-BCA	20	071863
Safety screws, stainless steel M4 x 14 (large head)	Safety switch CES-..-C.2, actuator CES-A-BLN.2 and actuator CTP (straight/angled)	100	086232
Safety screws, stainless steel M4 x 20	Safety switch CES+AP-...-C04 and actuator CES-A-BBN-C04-...	20	116978
Safety screws, stainless steel M5 x 10	Safety switch CES-..-C01, actuator CES-A-BPA and hinged actuator CTP (left/right)	100	073455
Safety screws M5 x 16	Actuators CES-A-BRN, CET-A-BWK and actuator A-C40	100	073456
Safety screws M5 x 25	Hinged actuator CTP (top/bottom)	100	073457

Miscellaneous accessories

Designation	Use	Version	Order no
C04 ATEX housing protection 	For safety switch CES-C04	–	137528 AM-C-C04-EX-137528
C40 Lockout bar 	For safety switch design C40	–	123625 AE-L-C40-123625
CTP Mechanical key release 	For safety switch CTP	Identical locking, including two keys	086236
		Identical locking, key removable only in <i>unlocked</i> position, including two keys	109212
		Unique locking, including two keys	084177
		Identical locking, key removable in <i>locked</i> position, including two keys	121917
CTP Replacement key 	For mechanical key release, identical locking	Two keys, identical locking	099434
CTP Release 	For safety switch CTP	Resetting	103110
CTP Emergency unlocking 	For safety switch CTP	–	099877
CTP Lead seal kit	For emergency unlocking	–	087256

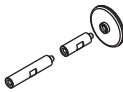
Designation	Use	Version	Order no
Wire front release 	For safety switch CTP	Resetting, sheath length 2 m (rope length 6 m)	097747 AE-B-A1-02,0F-097747
		Resetting, sheath length 3 m (rope length 6 m)	111233 AE-B-A1-03,0F-111233
CTP Handle for wire front release 	Suitable for all safety switches with wire front release		099795 AY-HDL-099795
			124204 AY-HDL-124204
Lockout bar 	For safety switch CTP	–	123411
Lockout bar 	For actuator CET	Suitable for shackle diameter 5 mm - 6 mm	122609 AE-L-CET-122609
Lockout bar 	For actuator CET	Suitable for shackle diameter 5 mm - 9 mm	156429 AE-L-CET-156429
Holder for lockout bar 	For lockout bar AE-L-CET-156420	Including wire rope and ring to hang the wire rope onto the lockout bar	156338 AY-CHN-A1-156338
CET Lockout bar + holder set 	For actuator CET	Suitable for shackle diameter 5 mm - 9 mm. Holder including wire rope and ring to hang the wire rope onto the lockout bar.	155865 AE-SET-LCHN-A1-155865
Mechanical key release 	For safety switch CET	Identical locking, including two keys	098850
Replacement key	For mechanical key release, identical locking	Two keys, identical locking	099434
Emergency unlocking 	For safety switch CET	Latching in both positions	103714
Lead seal kit	For emergency unlocking	–	087256
Cover 	For safety switch CET and actuator CET	Door hinge right	098808
		Door hinge left	098807
Cover 	For actuator CET	Horizontal and vertical fastening option on the actuator	124979 AM-C-124979

	Designation	Use	Version	Order no
	Double ramp 	For safety switch CET	-	114091
	Handle for wire front release 	Suitable for all safety switches with wire front release	 099795 AY-HDL-099795	
			 124204 AY-HDL-124204	
	Extension for escape release 	For safety switch CET	 127377 AF-E-80-127377	



Index by item designation

Item	Order no.	Page
A-C-HG-LS-EX-136826	136826	37
A-C-HG-SST-126015	126015	37, 70
A-C-HRL-LS-122671	122671	37, 70
A-C-HRO-LS-122675	122675	37, 70
A-C-HRR-LS-122672	122672	37, 70
A-C-HRULS-122676	122676	37, 70
A-C-HW-SST-122667	122667	37, 70
A-C-HW-SST-122668	122668	37, 70
A-C40-113869	113869	66, 90
A-TI001-125481	125481	66, 90
AC-DP-04-SAA-120861	120861	102
AC-SP-A1-SA-123340	123340	102
AC-TA-A1-SG-125496	125496	107
AC-TA-A1-SH-122748	122748	107
AC-TA-A2-SG-125497	125497	107
AC-TA-A2-SH-122749	122749	107
AC-YD-V0,2-SBB-124516	124516	107
AE-B-A1-02,0F-097747	097747	117
AE-B-A1-03,0F-111233	111233	117
AE-L-C40-123625	123625	116
AE-L-CET-122609	122609	117
AE-L-CET-156429	156429	117
AE-SET-LCHN-A1-155865	155865	117
AF-E-80-127377	127377	118
AMB-126230	126230	114
AMB-126231	126231	114
AMC-124979	124979	117
AMC-C04-EX-137528	137528	116
AMP-126026	126026	114
AMP-126398	126398	115
AMP-126399	126399	115
AMP-126400	126400	115
AM-SET-PP-119690	119690	114
AM-SET-PPB-119694	119694	114
AY-CHN-A1-156338	156338	117
AY-HDL-099795	099795	117, 118
AY-HDL-124204	124204	117, 118
C-M08F04-04X025PV02,0-ES-088812	088812	95
C-M08F04-04X025PV05,0-ES-088813	088813	95
C-M08F04-04X025PV10,0-ES-084703	084703	95
C-M08F04-04X025PV10,0-ES-088814	088814	95
C-M08F04-04X025PV15,0-ES-088815	088815	95
C-M08F04-04X025PV25,0-ES-095035	095035	95
C-M08F04-04X025PV50,0-ES-097100	097100	95
C-M08F04-04X034PU05,0-ES-116049	116049	95
C-M08F04-04X034PU10,0-ES-116050	116050	95
C-M08F04-04X034PU20,0-ES-116051	116051	95
C-M08F04-04X034PU50,0-ES-120241	120241	95
C-M08F08-08X014PU05,0-ES-106671	106671	96
C-M08F08-08X014PU10,0-ES-106672	106672	96
C-M08F08-08X014PU20,0-ES-106673	106673	96
C-M08F08-08X014PV05,0-ES-110933	110933	96
C-M08F08-08X014PV10,0-ES-110934	110934	96
C-M08F08-08X014PV15,0-ES-110935	110935	96
C-M08F08-08X014PV20,0-ES-111603	111603	96
C-M12F05-05X025PU10,0-M12M05-115565	115565	97
C-M12F05-05X025PU10,0-M12M05-115566	115566	97
C-M12F05-05X025PU10,0-MA-113187	113187	97
C-M12F05-05X025PU10,0-MA-113190	113190	97
C-M12F05-05X034PU05,0-M12M05-119932	119932	98
C-M12F05-05X034PU05,0-MA-113620	113620	98
C-M12F05-05X034PU10,0-M12M05-119947	119947	98
C-M12F05-05X034PU10,0-MA-113640	113640	98

Item	Order no.	Page
C-M12F05-05X034PU20,0-M12M05-119971	119971	98
C-M12F05-05X034PU20,0-MA-113682	113682	98
C-M12F05-05X034PU30,0-MA-113682	122784	98
C-M12F05-05X034PV05,0-M12M05-100180	100180	97
C-M12F05-05X034PV05,0-MA-100183	100183	97
C-M12F05-05X034PV10,0-M12M05-100181	100181	97
C-M12F05-05X034PV10,0-MA-100184	100184	97
C-M12F05-05X034PV20,0-M12M05-100182	100182	97
C-M12F05-05X034PV20,0-MA-100185	100185	97
C-M12F05-05X034PV50,0-MA-156064	156064	97
C-M12F08-08X025PU05,0-MA-115112	115112	99
C-M12F08-08X025PU10,0-MA-113188	113188	100
C-M12F08-08X025PU10,0-MA-113189	113189	100
C-M12F08-08X025PU10,0-MA-115113	115113	99
C-M12F08-08X025PU20,0-MA-115114	115114	99
C-M12F08-08X025PU20,0-MA-120998	120998	100
C-M12F08-08X025PU20,0-MA-120999	120999	100
C-M12F08-08X025PU30,0-MA-115257	115257	99
C-M12F08-08X025PV05,0-GA-077751	077751	103
C-M12F08-08X025PV05,0-MA-100177	100177	99
C-M12F08-08X025PV10,0-GA-077752	077752	103
C-M12F08-08X025PV10,0-MA-100178	100178	99
C-M12F08-08X025PV15,0-GA-077753	077753	103
C-M12F08-08X025PV20,0-GA-077871	077871	103
C-M12F08-08X025PV20,0-MA-100179	100179	99
C-M12F08-08X025PV25,0-GA-077872	077872	103
C-M12F08-08X025PV30,0-MA-115116	115116	99
C-M12F08-08X025PV50,0-GA-077873	077873	103
C-M12M08-08X025PV01,0-M12F08-123430	123430	99
C-M12M08-08X025PV02,0-M12F08-123431	123431	99
C-M12M08-08X025PV05,0-M12F08-123432	123432	99
C-M12M08-08X025PV10,0-M12F08-123433	123433	99
C-M23F19-19XDIFPU01,5-MA-092761	092761	104
C-M23F19-19XDIFPU01,5-MA-092906	092906	105
C-M23F19-19XDIFPU01,5-MA-092907	092907	105
C-M23F19-19XDIFPU03,0-MA-092816	092816	104
C-M23F19-19XDIFPU03,0-MA-092908	092908	105
C-M23F19-19XDIFPU03,0-MA-092909	092909	105
C-M23F19-19XDIFPU06,0-MA-077014	077014	104
C-M23F19-19XDIFPU06,0-MA-077018	077018	105
C-M23F19-19XDIFPU06,0-MA-085194	085194	105
C-M23F19-19XDIFPU08,0-MA-077015	077015	104
C-M23F19-19XDIFPU08,0-MA-077015	092898	104
C-M23F19-19XDIFPU08,0-MA-077019	077019	105
C-M23F19-19XDIFPU08,0-MA-085195	085195	105
C-M23F19-19XDIFPU10,0-MA-092901	092901	105
C-M23F19-19XDIFPU10,0-MA-092902	092902	105
C-M23F19-19XDIFPU15,0-MA-077016	077016	104
C-M23F19-19XDIFPU15,0-MA-077020	077020	105
C-M23F19-19XDIFPU15,0-MA-085196	085196	105
C-M23F19-19XDIFPU20,0-MA-092726	092726	104
C-M23F19-19XDIFPU20,0-MA-092910	092910	105
C-M23F19-19XDIFPU20,0-MA-092911	092911	105
C-M23F19-19XDIFPU25,0-MA-092727	092727	104
C-M23F19-19XDIFPU25,0-MA-092912	092912	105
C-M23F19-19XDIFPU25,0-MA-092913	092913	105
C-M23F19-19XDIFPU30,0-MA-095993	095993	104
C-M23F19-19XDIFPU40,0-MA-102490	102490	104
C-R08F06-06X014PV05,0-ES-103556	103556	94
C-R08F06-06X014PV10,0-ES-103557	103557	94
C-R08F06-06X014PV15,0-ES-103558	103558	94
C-R08F06-06X014PV20,0-ES-103559	103559	94
C-R08F06-06X014PV25,0-ES-103560	103560	94

Item	Order no.	Page
CEM2-AR-M-C40-SH-113739	113739	66
CEM2-AR-U-C40-SH-124937	124937	66
CEM2-AY-U-C40-SA-128103	128103	90
CES-A-BBA	071840	16, 20, 24, 54
CES-A-BBA-EX-098158	098158	16
CES-A-BBN-C04-115271	115271	31, 61
CES-A-BBN-C04-EX-137527	137527	31, 61
CES-A-BCA	088786	16, 20, 24, 54
CES-A-BDA-18	156935	24, 54
CES-A-BDN-06-104730	104730	27, 31, 57, 61
CES-A-BLNL2-104510	104510	27, 57
CES-A-BLNR2-100776	100776	27, 57
CES-A-BLNU2-103450	103450	27, 57
CES-A-BPA	098775	16, 20, 24, 54
CES-A-BPA-EX-102125	102125	16
CES-A-BRN-100251	100251	20, 24, 54
CES-A-C5E-01	077750	16
CES-A-C5H-01	091458	16
CES-A-C5H-01-EX	097945	16
CES-A-W5H-01	097525	16
CES-AH-C03-AH-SM-106300	106300	20
CES-AP-C01-AH-SB-111145	111145	24
CES-AP-C01-CH-SA-100250	100250	24
CES-AP-C01-CH-SB-106798	106798	24
CES-AP-C01-CH-SB-111708	111708	24
CES-AP-CL2-AHL05-105603	105603	26
CES-AP-CL2-AHL10-106192	106192	26
CES-AP-CL2-AHL20-106196	106196	26
CES-AP-CL2-AH-SB-106553	106553	26
CES-AP-CL2-AH-SB-111747	111747	26
CES-AP-CL2-AH-SF-105294	105294	26
CES-AP-CL2-CHL05-105602	105602	27
CES-AP-CL2-CHL10-106190	106190	27
CES-AP-CL2-CHL20-106194	106194	27
CES-AP-CL2-CH-SB-106551	106551	27
CES-AP-CL2-CH-SB-109167	109167	27
CES-AP-CL2-CH-SF-104509	104509	27
CES-AP-CR2-AHL05-105601	105601	26
CES-AP-CR2-AHL10-106191	106191	26
CES-AP-CR2-AHL20-106195	106195	26
CES-AP-CR2-AH-SB-106552	106552	26
CES-AP-CR2-AH-SB-111748	111748	26
CES-AP-CR2-AH-SF-105295	105295	26
CES-AP-CR2-CHL05-105600	105600	27
CES-AP-CR2-CHL10-106189	106189	27
CES-AP-CR2-CHL20-106193	106193	27
CES-AP-CR2-CH-SB-106550	106550	27
CES-AP-CR2-CH-SB-109168	109168	27
CES-AP-CR2-CH-SB-123922	123922	27
CES-AP-CR2-CH-SF-100775	100775	27
CES-AR-AES-12	098225	86
CES-AR-C01-AH-SA	098941	54
CES-AR-C01-CH-SA	098942	54
CES-AR-C01-EH-SA	098582	54
CES-AR-CL2-AHL05-109047	109047	56
CES-AR-CL2-AHL10-109051	109051	56
CES-AR-CL2-AHL20-109055	109055	56
CES-AR-CL2-AH-SA-105748	105748	56

Item	Order no.	Page
CES-AR-CL2-AH-SG-105753	105753	56
CES-AR-CL2-CHL05-109045	109045	57
CES-AR-CL2-CHL10-109049	109049	57
CES-AR-CL2-CHL20-109053	109053	57
CES-AR-CL2-CH-SA-105747	105747	57
CES-AR-CL2-CH-SA-112929	112929	57
CES-AR-CL2-CH-SA-115793	115793	57
CES-AR-CL2-CH-SG-105752	105752	57
CES-AR-CR2-AHL05-109046	109046	56
CES-AR-CR2-AHL10-109050	109050	56
CES-AR-CR2-AHL20-109054	109054	56
CES-AR-CR2-AH-SA-105746	105746	56
CES-AR-CR2-AH-SG-105751	105751	56
CES-AR-CR2-CHL05-109044	109044	57
CES-AR-CR2-CHL10-109048	109048	57
CES-AR-CR2-CHL20-109052	109052	57
CES-AR-CR2-CH-SA-105745	105745	57
CES-AR-CR2-CH-SA-112928	112928	57
CES-AR-CR2-CH-SA-115792	115792	57
CES-AR-CR2-CH-SG-105750	105750	57
CES-EA-TC-AK08-104776	104776	107
CES-EA-TC-KK08-112629	112629	107
CES-IAP-M-C04-SK-117325	117325	31
CES-IAP-M-C04-U05-117328	117328	31
CES-IAP-M-C04-U10-117329	117329	31
CES-IAP-M-C04-U20-117330	117330	31
CES-IAP-M-C04-USB-117324	117324	31
CES-IAP-M-C04-USI-117323	117323	31
CES-IAP-U-C04-SK-115324	115324	30
CES-IAP-U-C04-U05-116503	116503	30
CES-IAP-U-C04-U10-116504	116504	30
CES-IAP-U-C04-U20-116505	116505	30
CES-IAP-U-C04-USB-116502	116502	30
CES-IAP-U-C04-USI-115150	115150	30
CES-IAR-M-C04-SG-119474	119474	61
CES-IAR-M-C04-U05-119475	119475	61
CES-IAR-M-C04-U10-119476	119476	61
CES-IAR-M-C04-U20-119477	119477	61
CES-IAR-M-C04-USA-119479	119479	61
CES-IAR-U-C04-SG-119469	119469	60
CES-IAR-U-C04-U05-119470	119470	60
CES-IAR-U-C04-U10-119471	119471	60
CES-IAR-U-C04-U20-119472	119472	60
CES-IAR-U-C04-USA-119473	119473	60
CET-A-BWK-50X	096327	46, 80
CET1-AR-CDA-AH-50X-SG-106275	106275	77
CET1-AR-CDA-CH-50X-SG-109231	109231	77
CET1-AR-CDA-CH-50X-SH-113255	113255	79
CET1-AR-CRA-AH-50A-SG-106616	106616	77
CET1-AR-CRA-AH-50F-SG-106159	106159	77
CET1-AR-CRA-AH-50F-SH-C2312-110943	110943	79
CET1-AR-CRA-AH-50F-SH-C2353-113021	113021	79
CET1-AR-CRA-AH-50S-SG-105802	105802	77
CET1-AR-CRA-AH-50S-SG-C2290-113320	113320	77
CET1-AR-CRA-AH-50X-SG-103418	103418	77
CET1-AR-CRA-AH-50X-SH-110203	110203	79
CET1-AR-CRA-AH-50X-SH-C2290-113022	113022	79
CET1-AR-CRA-CH-50F-SG-110241	110241	77
CET1-AR-CRA-CH-50F-SH-C2312-124104	124104	79
CET1-AR-CRA-CH-50S-SG-105764	105764	77
CET1-AR-CRA-CH-50X-SG-105763	105763	77
CET1-AR-CRA-CH-50X-SG-C2290-109015	109015	77
CET1-AR-CRA-CH-50X-SH-110204	110204	79

Item	Order no.	Page
CET2-AR-CDA-AH-50X-SH-112446	112446	79
CET2-AR-CRA-AH-50S-SG-109075	109075	77
CET2-AR-CRA-AH-50X-SG-110240	110240	77
CET2-AR-CRA-AH-50X-SH-110205	110205	79
CET2-AR-CRA-CH-50F-SG-C2312-109941	109941	77
CET2-AR-CRA-CH-50X-SG-110082	110082	77
CET2-AR-CRA-CH-50X-SH-110206	110206	79
CET3-AP-CRA-AH-50F-SA-124601	124601	46
CET3-AP-CRA-AH-50F-SH-C2312-119106	119106	46
CET3-AP-CRA-AH-50F-SI-114073	114073	45
CET3-AP-CRA-AH-50F-SI-C2312-157408	157408	45
CET3-AP-CRA-AH-50F-SI-C2438-127594	124594	45
CET3-AP-CRA-AH-50X-SA-122389	122398	46
CET3-AP-CRA-AH-50X-SA-122406	122406	46
CET3-AP-CRA-AH-50X-SI-111346	111346	45
CET3-AP-CRA-AH-50X-SI-C2290-121367	121367	45
CET3-AP-CRA-AH-50X-SI-C2438-124589	124589	45
CET3-AP-CRA-CH-50F-SAC2312-157287	157287	46
CET3-AP-CRA-CH-50X-SA-121579	121579	46
CET3-AP-CRA-CH-50X-SA-122409	122409	46
CET3-AR-CDA-AH-50F-SH-114647	114647	80
CET3-AR-CDA-CH-50F-SG-114090	114090	78
CET3-AR-CRA-AH-50F-SG-113965	113965	78
CET3-AR-CRA-AH-50F-SH-113148	113148	80
CET3-AR-CRA-AH-50F-SH-C2312-111725	111725	80
CET3-AR-CRA-AH-50F-SH-C2353-113023	113023	80
CET3-AR-CRA-AH-50X-SG-109401	109401	78
CET3-AR-CRA-AH-50X-SG-C2290-113139	113139	78
CET3-AR-CRA-AH-50X-SH-110103	110103	80
CET3-AR-CRA-AH-50X-SH-C2290-113024	113024	80
CET3-AR-CRA-AH-50X-SH-C2290-114088	114088	80
CET3-AR-CRA-AH-50X-SH-C2375-115202	115202	80
CET3-AR-CRA-CH-50F-SG-110907	110907	78
CET3-AR-CRA-CH-50F-SG-C2290-110905	110905	78
CET3-AR-CRA-CH-50S-SG-112992	112992	78
CET3-AR-CRA-CH-50X-SG-110906	110906	78
CET3-AR-CRA-CH-50X-SG-C2290-110114	110114	78
CET3-AR-CRA-CH-50X-SH-110104	110104	80
CET4-AP-CRA-AH-50X-SA-122415	122415	46
CET4-AP-CRA-AH-50X-SI-112082	112082	45
CET4-AP-CRA-AH-50X-SI-C2438-126763	126763	45
CET4-AP-CRA-CH-50X-SA-122413	122413	46
CET4-AR-CDA-CH-50X-SG-114712	114712	78
CET4-AR-CRA-AH-50F-SH-116285	116285	80
CET4-AR-CRA-AH-50X-SG-111683	111683	78
CET4-AR-CRA-AH-50X-SG-C2290-128193	128193	78
CET4-AR-CRA-AH-50X-SH-110201	110201	80
CET4-AR-CRA-CH-50F-SG-114650	114650	78
CET4-AR-CRA-CH-50S-SG-113081	113081	78
CET4-AR-CRA-CH-50X-SG-111684	111684	78
CET4-AR-CRA-CH-50X-SG-C2355-113609	113609	78
CET4-AR-CRA-CH-50X-SH-110202	110202	80
CTP-I1-AP-UHA-AEC-SA-136595	136595	35
CTP-I2-AP-UHA-AZC-SA-126258	126258	35
CTP-I2-AR-MHA-AZC-SAB-124067	124067	69
CTP-L1-AP-MHA-AE-SH-123376	123376	36
CTP-L1-AP-MHA-AZ-SA-124727	124727	35
CTP-L1-AP-MHA-AZ-SH-123365	123365	36
CTP-L1-AP-UHA-AE-SA-126912	126912	35
CTP-L1-AP-UHA-AE-SH-123375	123375	36
CTP-L1-AP-UHA-AE-SII-127640	127640	35
CTP-L1-AP-UHA-AE-SII-129478	129478	35
CTP-L1-AP-UHA-AEE-SH-137342	137342	36

Item	Order no.	Page
CTP-L1-AP-UHA-AZ-SA-EX-129512	129512	36
CTP-L1-AP-UHA-AZ-SA-124225	124225	35
CTP-L1-AP-UHA-AZ-SA-EX-136675	136675	36
CTP-L1-AP-UHA-AZ-SH-123364	123364	36
CTP-L1-AP-UHA-AZ-SII-124468	124468	35
CTP-L1-AP-UHA-AZ-SII-129477	129477	35
CTP-L1-AP-UHA-AZE-SH-156056	156056	36
CTP-L1-AR-MHA-AE-SAB-123308	123308	69
CTP-L1-AR-MHA-AE-SH-123374	123374	69
CTP-L1-AR-MHA-AZ-SAB-123307	123307	69
CTP-L1-AR-MHA-AZ-SH-123363	123363	69
CTP-L1-AR-UHA-AE-SAB-122813	122813	69
CTP-L1-AR-UHA-AE-SH-123373	123373	69
CTP-L1-AR-UHA-AEE-SH-137164	137164	70
CTP-L1-AR-UHA-AZ-SAB-122812	122812	69
CTP-L1-AR-UHA-AZ-SH-123362	123362	69
CTP-L1-AR-UHA-AZE-SH-126874	126874	70
CTP-L1-AR-UHA-AZE-SH-137341	137341	70
CTP-L2-AP-MHA-AZ-SA-124729	124729	35
CTP-L2-AP-MHA-AZ-SH-123371	123371	36
CTP-L2-AP-UHA-AE-SA-136841	136841	35
CTP-L2-AP-UHA-AZ-SA-124728	124728	35
CTP-L2-AP-UHA-AZ-SH-123370	123370	36
CTP-L2-AR-MHA-AZ-SAB-123361	123361	69
CTP-L2-AR-MHA-AZ-SH-123369	123369	69
CTP-L2-AR-UHA-AZ-SAB-122814	122814	69
CTP-L2-AR-UHA-AZ-SH-123366	123366	69
CTP-L2-AR-UHA-AZE-SH-137165	137165	70
CTP-LBI-AP-UHA-AZ-SA-127798	127798	35
EMP-B-CET	106694	115
EMP-B1	093457	114, 115
EMP-B2	093458	114
EMP-L-CET	106695	115
EMP-SB	093456	114
ESL-IH-AR-M-R30-SA-114943	114943	64
ESL-IH-AR-M-R30-SA-120646	120646	64
ESL-IH-AR-U-R30-SA-115320	115320	64
ESL-IH-AR-U-R30-SA-120824	120824	64

Index by order number

Order no.	Item	Page	Order no.	Item	Page
071840	CES-A-BBA	16, 20, 24, 54	097100	C-M08F04-04X025PV50,0-ES-097100	95
071863		116	097525	CES-A-W5H-01	16
073455		116	097627		101
073456		116	097645		101
073457		116	097747	AE-B-A1-02,0F-097747	117
074616		106	097945	CES-A-C5H-01-EX	16
074617		106	098158	CES-A-BBA-EX-098158	16
077014	C-M23F19-19XDIFPU06,0-MA-077014	104	098225	CES-AR-AES-12	86
077015	C-M23F19-19XDIFPU08,0-MA-077015	104	098357		108
077016	C-M23F19-19XDIFPU15,0-MA-077016	104	098582	CES-AR-C01-EH-SA	54
077018	C-M23F19-19XDIFPU06,0-MA-077018	105	098775	CES-A-BPA	16, 20, 24, 54
077019	C-M23F19-19XDIFPU08,0-MA-077019	105	098807		117
077020	C-M23F19-19XDIFPU15,0-MA-077020	105	098808		117
077025		106	098850		117
077026		106	098941	CES-AR-C01-AH-SA	54
077750	CES-A-C5E-01	16	098942	CES-AR-C01-CH-SA	54
077751	C-M12F08-08X025PV05,0-GA-077751	103	099434		116, 117
077752	C-M12F08-08X025PV10,0-GA-077752	103	099795	AY-HDL-099795	117, 118
077753	C-M12F08-08X025PV15,0-GA-077753	103	099877		116
077871	C-M12F08-08X025PV20,0-GA-077871	103	100177	C-M12F08-08X025PV05,0-MA-100177	99
077872	C-M12F08-08X025PV25,0-GA-077872	103	100178	C-M12F08-08X025PV10,0-MA-100178	99
077873	C-M12F08-08X025PV50,0-GA-077873	103	100179	C-M12F08-08X025PV20,0-MA-100179	99
082220		108	100180	C-M12F05-05X034PV05,0-M12M05-100180	97
084177		116	100181	C-M12F05-05X034PV10,0-M12M05-100181	97
084703	C-M08F04-04X025PV10,0-ES-084703	95	100182	C-M12F05-05X034PV20,0-M12M05-100182	97
085194	C-M23F19-19XDIFPU06,0-MA-085194	105	100183	C-M12F05-05X034PV05,0-MA-100183	97
085195	C-M23F19-19XDIFPU08,0-MA-085195	105	100184	C-M12F05-05X034PV10,0-MA-100184	97
085196	C-M23F19-19XDIFPU15,0-MA-085196	105	100185	C-M12F05-05X034PV20,0-MA-100185	97
086232		116	100250	CES-AP-C01-CH-SA-100250	24
086236		116	100251	CES-A-BRN-100251	20, 24, 54
087256		116, 117	100775	CES-AP-CR2-CH-SF-100775	27
088786	CES-A-BCA	16, 20, 24, 54	100776	CES-A-BLN-R2-100776	27, 57
088812	C-M08F04-04X025PV02,0-ES-088812	95	102125	CES-A-BPA-EX-102125	16
088813	C-M08F04-04X025PV05,0-ES-088813	95	102490	C-M23F19-19XDIFPU40,0-MA-102490	104
088814	C-M08F04-04X025PV10,0-ES-088814	95	103110		116
088815	C-M08F04-04X025PV15,0-ES-088815	95	103418	CET1-AR-CRA-AH-50X-SG-103418	77
091458	CES-A-C5H-01	16	103450	CES-A-BLN-U2-103450	27, 57
092726	C-M23F19-19XDIFPU20,0-MA-092726	104	103556	C-R08F06-06X014PV05,0-ES-103556	94
092727	C-M23F19-19XDIFPU25,0-MA-092727	104	103557	C-R08F06-06X014PV10,0-ES-103557	94
092761	C-M23F19-19XDIFPU01,5-MA-092761	104	103558	C-R08F06-06X014PV15,0-ES-103558	94
092816	C-M23F19-19XDIFPU03,0-MA-092816	104	103559	C-R08F06-06X014PV20,0-ES-103559	94
092898	C-M23F19-19XDIFPU08,0-MA-077015	104	103560	C-R08F06-06X014PV25,0-ES-103560	94
092901	C-M23F19-19XDIFPU10,0-MA-092901	105	103714		117
092902	C-M23F19-19XDIFPU10,0-MA-092902	105	104028		109
092906	C-M23F19-19XDIFPU01,5-MA-092906	105	104309		112
092907	C-M23F19-19XDIFPU01,5-MA-092907	105	104509	CES-AP-CL2-CH-SF-104509	27
092908	C-M23F19-19XDIFPU03,0-MA-092908	105	104510	CES-A-BLN-L2-104510	27, 57
092909	C-M23F19-19XDIFPU03,0-MA-092909	105	104730	CES-A-BDN-06-104730	27, 31, 57, 61
092910	C-M23F19-19XDIFPU20,0-MA-092910	105	104776	CES-EA-TC-AK08-104776	107
092911	C-M23F19-19XDIFPU20,0-MA-092911	105	105294	CES-AP-CL2-AH-SF-105294	26
092912	C-M23F19-19XDIFPU25,0-MA-092912	105	105295	CES-AP-CR2-AH-SF-105295	26
092913	C-M23F19-19XDIFPU25,0-MA-092913	105	105600	CES-AP-CR2-CH-L05-105600	27
093456	EMP-SB	114	105601	CES-AP-CR2-AH-L05-105601	26
093457	EMP-B1	114, 115	105602	CES-AP-CL2-CH-L05-105602	27
093458	EMP-B2	114	105603	CES-AP-CL2-AH-L05-105603	26
094309		106	105619		109
094310		106	105745	CES-AR-CR2-CH-SA-105745	57
095035	C-M08F04-04X025PV25,0-ES-095035	95	105746	CES-AR-CR2-AH-SA-105746	56
095993	C-M23F19-19XDIFPU30,0-MA-095993	104	105747	CES-AR-CL2-CH-SA-105747	57
096327	CET-A-BWK-50X	46, 80	105748	CES-AR-CL2-AH-SA-105748	56
096613		111			

Order no.	Item	Page
105750	CES-AR-CR2-CH-SG-105750	57
105751	CES-AR-CR2-AH-SG-105751	56
105752	CES-AR-CL2-CH-SG-105752	57
105753	CES-AR-CL2-AH-SG-105753	56
105763	CET1-AR-CRA-CH-50X-SG-105763	77
105764	CET1-AR-CRA-CH-50S-SG-105764	77
105802	CET1-AR-CRA-AH-50S-SG-105802	77
106159	CET1-AR-CRA-AH-50F-SG-106159	77
106172		112
106189	CES-AP-CR2-CH-L10-106189	27
106190	CES-AP-CL2-CH-L10-106190	27
106191	CES-AP-CR2-AH-L10-106191	26
106192	CES-AP-CL2-AH-L10-106192	26
106193	CES-AP-CR2-CH-L20-106193	27
106194	CES-AP-CL2-CH-L20-106194	27
106195	CES-AP-CR2-AH-L20-106195	26
106196	CES-AP-CL2-AH-L20-106196	26
106275	CET1-AR-CDA-AH-50X-SG-106275	77
106300	CES-AH-C03-AH-SM-106300	20
106350		112
106550	CES-AP-CR2-CH-SB-106550	27
106551	CES-AP-CL2-CH-SB-106551	27
106552	CES-AP-CR2-AH-SB-106552	26
106553	CES-AP-CL2-AH-SB-106553	26
106597		106
106616	CET1-AR-CRA-AH-50A-SG-106616	77
106671	C-M08F08-08X014PU05,0-ES-106671	96
106672	C-M08F08-08X014PU10,0-ES-106672	96
106673	C-M08F08-08X014PU20,0-ES-106673	96
106694	EMP-B-CET	115
106695	EMP-L-CET	115
106798	CES-AP-C01-CH-SB-106798	24
109015	CET1-AR-CRA-CH-50X-SG-C2290-109015	77
109044	CES-AR-CR2-CH-L05-109044	57
109045	CES-AR-CL2-CH-L05-109045	57
109046	CES-AR-CR2-AH-L05-109046	56
109047	CES-AR-CL2-AH-L05-109047	56
109048	CES-AR-CR2-CH-L10-109048	57
109049	CES-AR-CL2-CH-L10-109049	57
109050	CES-AR-CR2-AH-L10-109050	56
109051	CES-AR-CL2-AH-L10-109051	56
109052	CES-AR-CR2-CH-L20-109052	57
109053	CES-AR-CL2-CH-L20-109053	57
109054	CES-AR-CR2-AH-L20-109054	56
109055	CES-AR-CL2-AH-L20-109055	56
109075	CET2-AR-CRA-AH-50S-SG-109075	77
109167	CES-AP-CL2-CH-SB-109167	27
109168	CES-AP-CR2-CH-SB-109168	27
109212		116
109231	CET1-AR-CDA-CH-50X-SG-109231	77
109358		109
109401	CET3-AR-CRA-AH-50X-SG-109401	78
109672		112
109941	CET2-AR-CRA-CH-50F-SG-C2312-109941	77
110082	CET2-AR-CRA-CH-50X-SG-110082	77
110103	CET3-AR-CRA-AH-50X-SH-110103	80
110104	CET3-AR-CRA-CH-50X-SH-110104	80
110114	CET3-AR-CRA-CH-50X-SG-C2290-110114	78
110201	CET4-AR-CRA-AH-50X-SH-110201	80
110202	CET4-AR-CRA-CH-50X-SH-110202	80
110203	CET1-AR-CRA-AH-50X-SH-110203	79
110204	CET1-AR-CRA-CH-50X-SH-110204	79
110205	CET2-AR-CRA-AH-50X-SH-110205	79

Order no.	Item	Page
110206	CET2-AR-CRA-CH-50X-SH-110206	79
110240	CET2-AR-CRA-AH-50X-SG-110240	77
110241	CET1-AR-CRA-CH-50F-SG-110241	77
110354		109
110355		109
110905	CET3-AR-CRA-CH-50F-SG-C2290-110905	78
110906	CET3-AR-CRA-CH-50X-SG-110906	78
110907	CET3-AR-CRA-CH-50F-SG-110907	78
110933	C-M08F08-08X014PV05,0-ES-110933	96
110934	C-M08F08-08X014PV10,0-ES-110934	96
110935	C-M08F08-08X014PV15,0-ES-110935	96
110943	CET1-AR-CRA-AH-50F-SH-C2312-110943	79
111145	CES-AP-C01-AH-SB-111145	24
111233	AE-B-A1-03,0-F-111233	117
111346	CET3-AP-CRA-AH-50X-SH-111346	45
111603	C-M08F08-08X014PV20,0-ES-111603	96
111683	CET4-AR-CRA-AH-50X-SG-111683	78
111684	CET4-AR-CRA-CH-50X-SG-111684	78
111696		101
111708	CES-AP-C01-CH-SB-111708	24
111725	CET3-AR-CRA-AH-50F-SH-C2312-111725	80
111747	CES-AP-CL2-AH-SB-111747	26
111748	CES-AP-CR2-AH-SB-111748	26
112082	CET4-AP-CRA-AH-50X-SH-112082	45
112395		101
112446	CET2-AR-CDA-AH-50X-SH-112446	79
112629	CES-EA-TC-KK08-112629	107
112928	CES-AR-CR2-CH-SA-112928	57
112929	CES-AR-CL2-CH-SA-112929	57
112992	CET3-AR-CRA-CH-50S-SG-112992	78
113021	CET1-AR-CRA-AH-50F-SH-C2353-113021	79
113022	CET1-AR-CRA-AH-50X-SH-C2290-113022	79
113023	CET3-AR-CRA-AH-50F-SH-C2353-113023	80
113024	CET3-AR-CRA-AH-50X-SH-C2290-113024	80
113081	CET4-AR-CRA-CH-50S-SG-113081	78
113139	CET3-AR-CRA-AH-50X-SG-C2290-113139	78
113148	CET3-AR-CRA-AH-50F-SH-113148	80
113187	C-M12F05-05X025PU10,0-MA-113187	97
113188	C-M12F08-08X025PU10,0-MA-113188	100
113189	C-M12F08-08X025PU10,0-MA-113189	100
113190	C-M12F05-05X025PU10,0-MA-113190	97
113255	CET1-AR-CDA-CH-50X-SH-113255	79
113320	CET1-AR-CRA-AH-50S-SG-C2290-113320	77
113609	CET4-AR-CRA-CH-50X-SG-C2355-113609	78
113620	C-M12F05-05X034PU05,0-MA-113620	98
113640	C-M12F05-05X034PU10,0-MA-113640	98
113682	C-M12F05-05X034PU20,0-MA-113682	98
113739	CEM2-AR-M-C40-SH-113739	66
113869	A-C40-113869	66, 90
113965	CET3-AR-CRA-AH-50F-SG-113965	78
113986		109
114073	CET3-AP-CRA-AH-50F-SH-114073	45
114088	CET3-AR-CRA-AH-50X-SH-C2290-114088	80
114090	CET3-AR-CDA-CH-50F-SG-114090	78
114091		118
114647	CET3-AR-CDA-AH-50F-SH-114647	80
114650	CET4-AR-CRA-CH-50F-SG-114650	78
114712	CET4-AR-CDA-CH-50X-SG-114712	78
114943	ESL-IH-AR-M-R30-SA-114943	64
115112	C-M12F08-08X025PU05,0-MA-115112	99
115113	C-M12F08-08X025PU10,0-MA-115113	99
115114	C-M12F08-08X025PU20,0-MA-115114	99
115116	C-M12F08-08X025PV30,0-MA-115116	99

Order no.	Item	Page	Order no.	Item	Page
115150	CES+AP-U-C04-USI-115150	30	122675	A-C-HRO-LS-122675	37, 70
115202	CET3-AR-CRA-AH-50X-SH-C2375-115202	80	122676	A-C-HRU-LS-122676	37, 70
115257	C-M12F08-08X025PU30,0-MA-115257	99	122748	AC-TA-A1-SH-122748	107
115271	CES-A-BBN-C04-115271	31, 61	122749	AC-TA-A2-SH-122749	107
115320	ESL-IH-AR-UR30-SA-115320	64	122784	C-M12F05-05X034PU30,0-MA-113682	98
115324	CES+AP-U-C04-SK-115324	30	122812	CTP-L1-AR-U-HA-AZ-SAB-122812	69
115565	C-M12F05-05X025PU10,0-M12M05-115565	97	122813	CTP-L1-AR-U-HA-AE-SAB-122813	69
115566	C-M12F05-05X025PU10,0-M12M05-115566	97	122814	CTP-L2-AR-U-HA-AZ-SAB-122814	69
115732		109	123307	CTP-L1-AR-M-HA-AZ-SAB-123307	69
115792	CES-AR-CR2-CH-SA-115792	57	123308	CTP-L1-AR-M-HA-AE-SAB-123308	69
115793	CES-AR-CL2-CH-SA-115793	57	123340	AC-SP-A1-SA-123340	102
116049	C-M08F04-04X034PU05,0-ES-116049	95	123361	CTP-L2-AR-M-HA-AZ-SAB-123361	69
116050	C-M08F04-04X034PU10,0-ES-116050	95	123362	CTP-L1-AR-U-HA-AZ-SH-123362	69
116051	C-M08F04-04X034PU20,0-ES-116051	95	123363	CTP-L1-AR-M-HA-AZ-SH-123363	69
116246		109	123364	CTP-L1-AP-U-HA-AZ-SH-123364	36
116285	CET4-AR-CRA-AH-50F-SH-116285	80	123365	CTP-L1-AP-M-HA-AZ-SH-123365	36
116502	CES+AP-U-C04-USB-116502	30	123366	CTP-L2-AR-U-HA-AZ-SH-123366	69
116503	CES+AP-U-C04-U05-116503	30	123369	CTP-L2-AR-M-HA-AZ-SH-123369	69
116504	CES+AP-U-C04-U10-116504	30	123370	CTP-L2-AP-U-HA-AZ-SH-123370	36
116505	CES+AP-U-C04-U20-116505	30	123371	CTP-L2-AP-M-HA-AZ-SH-123371	36
116978		116	123373	CTP-L1-AR-U-HA-AE-SH-123373	69
117323	CES+AP-M-C04-USI-117323	31	123374	CTP-L1-AR-M-HA-AE-SH-123374	69
117324	CES+AP-M-C04-USB-117324	31	123375	CTP-L1-AP-U-HA-AE-SH-123375	36
117325	CES+AP-M-C04-SK-117325	31	123376	CTP-L1-AP-M-HA-AE-SH-123376	36
117328	CES+AP-M-C04-U05-117328	31	123411		117
117329	CES+AP-M-C04-U10-117329	31	123430	C-M12M08-08X025PV01,0-M12F08-123430	99
117330	CES+AP-M-C04-U20-117330	31	123431	C-M12M08-08X025PV02,0-M12F08-123431	99
119106	CET3-AP-CRA-AH-50F-SH-C2312-119106	46	123432	C-M12M08-08X025PV05,0-M12F08-123432	99
119469	CES+AR-U-C04-SG-119469	60	123433	C-M12M08-08X025PV10,0-M12F08-123433	99
119470	CES+AR-U-C04-U05-119470	60	123583		110
119471	CES+AR-U-C04-U10-119471	60	123625	AE-L-C40-123625	116
119472	CES+AR-U-C04-U20-119472	60	123653		111
119473	CES+AR-U-C04-USA-119473	60	123655		111
119474	CES+AR-M-C04-SG-119474	61	123657		111
119475	CES+AR-M-C04-U05-119475	61	123658		111
119476	CES+AR-M-C04-U10-119476	61	123659		111
119477	CES+AR-M-C04-U20-119477	61	123660		111
119479	CES+AR-M-C04-USA-119479	61	123922	CES-AP-CR2-CH-SB-123922	27
119690	AM-SET-PP-119690	114	124067	CTP-I2-AR-M-HA-AZC-SAB-124067	69
119694	AM-SET-PPB-119694	114	124104	CET1-AR-CRA-CH-50F-SH-C2312-124104	79
119932	C-M12F05-05X034PU05,0-M12M05-119932	98	124204	AY-HDL-124204	117, 118
119947	C-M12F05-05X034PU10,0-M12M05-119947	98	124225	CTP-L1-AP-U-HA-AZ-SA-124225	35
119971	C-M12F05-05X034PU20,0-M12M05-119971	98	124401		109
120241	C-M08F04-04X034PU50,0-ES-120241	95	124468	CTP-L1-AP-U-HA-AZ-SII-124468	35
120646	ESL-IH-AR-MR30-SA-120646	64	124516	AC-YD-V0,2-SBB-124516	107
120824	ESL-IH-AR-UR30-SA-120824	64	124589	CET3-AP-CRA-AH-50X-SI-C2438-124589	45
120861	AC-DP-04-SAA-120861	102	124594	CET3-AP-CRA-AH-50F-SI-C2438-127594	45
120998	C-M12F08-08X025PU20,0-MA-120998	100	124601	CET3-AP-CRA-AH-50F-SA-124601	46
120999	C-M12F08-08X025PU20,0-MA-120999	100	124727	CTP-L1-AP-M-HA-AZ-SA-124727	35
121367	CET3-AP-CRA-AH-50X-SI-C2290-121367	45	124728	CTP-L2-AP-U-HA-AZ-SA-124728	35
121579	CET3-AP-CRA-CH-50X-SA-121579	46	124729	CTP-L2-AP-M-HA-AZ-SA-124729	35
121646		110	124937	CEM-I2-AR-U-C40-SH-124937	66
121917		116	124979	AM-C-124979	117
122398	CET3-AP-CRA-AH-50X-SA-122389	46	125481	A-TI001-125481	66, 90
122406	CET3-AP-CRA-AH-50X-SA-122406	46	125496	AC-TA-A1-SG-125496	107
122409	CET3-AP-CRA-CH-50X-SA-122409	46	125497	AC-TA-A2-SG-125497	107
122413	CET4-AP-CRA-CH-50X-SA-122413	46	126015	A-C-H-G-SST-126015	37, 70
122415	CET4-AP-CRA-AH-50X-SA-122415	46	126026	AMP-126026	114
122609	AE-L-CET-122609	117	126230	AMB-126230	114
122667	A-C-H-W-SST-122667	37, 70	126231	AMB-126231	114
122668	A-C-H-W-SST-122668	37, 70	126258	CTP-I2-AP-U-HA-AZC-SA-126258	35
122671	A-C-H-RL-LS-122671	37, 70	126398	AMP-126398	115
122672	A-C-H-RR-LS-122672	37, 70	126399	AMP-126399	115

A series of 30 horizontal grey bars stacked vertically, providing a space for taking notes. Each bar is uniform in width and height, and they span most of the page width.

A series of 30 horizontal grey bars, evenly spaced, intended for writing notes. The bars span most of the width of the page, leaving a small margin on the left and right.

A series of 30 horizontal grey lines spanning the width of the page, intended for taking notes.

Representatives

International

Austria

EUCHNER GmbH
Aumühlweg 17-19/Halle 1C
2544 Leobersdorf
Tel. +43 720 010 200
Fax +43 720 010 200-20
info@euchner.at

Benelux

EUCHNER (BENELUX) BV
Visschersbuurt 23
3356 AE Papendrecht
Tel. +31 78 615-4766
Fax +31 78 615-4311
info@euchner.nl

Brazil

EUCHNER Com.Comp.
Eletronicos Ltda.
Av. Prof. Luiz Ignácio Anhaia Mello,
no. 4387
Vila Graciosa
São Paulo - SP - Brasil
CEP 03295-000
Tel. +55 11 29182200
Fax +55 11 23010613
euchner@euchner.com.br

Canada

EUCHNER Canada Inc.
2105 Fasan Drive
Oldcastle, ON NOR 1L0
Tel. +1 519 800-8397
Fax +1 519 737-0314
sales@euchner.ca

China

EUCHNER (Shanghai)
Trading Co., Ltd.
No. 15 building,
No. 68 Zhongchuang Road,
Songjiang
Shanghai, 201613, P.R.C
Tel. +86 21 5774-7090
Fax +86 21 5774-7599
info@euchner.com.cn

Czech Republic

EUCHNER electric s.r.o.
Trnkova 3069/117h
628 00 Brno
Tel. +420 533 443-150
Fax +420 533 443-153
info@euchner.cz

Denmark

Duelco A/S
Systemvej 8 - 10
9200 Aalborg SV
Tel. +45 7010 1007
Fax +45 7010 1008
info@duelco.dk

Finland

Sähkölehto Oy
Holkkitie 14
00880 Helsinki
Tel. +358 9 7746420
office@sahkolehto.fi

France

EUCHNER France S.A.R.L.
Parc d'Affaires des Bellevues
Allée Rosa Luxembourg
Bâtiment le Colorado
95610 ERAGNY sur OISE
Tel. +33 1 3909-9090
Fax +33 1 3909-9099
info@euchner.fr

Hungary

EUCHNER Magyarország Kft.
FSD Park 2,
2045 Törökbálint
Tel. +36 1 919 0855
Fax +36 1 919 0857
info@euchner.hu

India

EUCHNER (India) Pvt. Ltd.
401, Bremen Business Center,
City Survey No. 2562,
University Road
Aundh, Pune - 411007
Tel. +91 20 64016384
Fax +91 20 25885148
info@euchner.in

Israel

Ilan & Gavish Automation Service Ltd.
26 Shenkar St. Qiryat Arie 49513
P.O. Box 10118
Petach Tikva 49001
Tel. +972 3 9221824
Fax +972 3 9240761
mail@ilan-gavish.com

Italy

TRITECNICA SpA
Viale Lazio 26
20135 Milano
Tel. +39 02 541941
Fax +39 02 55010474
info@tritecnica.it

Japan

EUCHNER Co., Ltd.
1662-3 Komakiharashinden
Komaki-shi, Aichi-ken
485-0012, Japan
Tel. +81 568 42 0157
Fax +81 568 42 0159
info@euchner.jp

Korea

EUCHNER Korea Co., Ltd.
115 Gasan Digital 2 - Ro
(Gasan-dong, Daeryung
Technotown 3rd Rm 810)
153 - 803 Kumchon-Gu, Seoul
Tel. +82 2 2107-3500
Fax +82 2 2107-3999
info@euchner.co.kr

Mexico

EUCHNER México S de RL de CV
95610 ERAGNY sur OISE
Conjunto Industrial PK Co.
Carretera Estatal 431 km. 1+300
Ejido El Colorado, El Marqués
76246 Querétaro, México
Tel. +52 442 402 1485
Fax +52 442 402 1486
info@euchner.mx

Poland

ELTRON
Pl. Wolności 7B
50-071 Wrocław
Tel. +48 71 3439755
Fax +48 71 3441141
eltron@eltron.pl

Portugal

PAM Servicos Tecnicos Industriais Lda.
Rua de Timor - Pavilhao 2A
Zona Industrial da Abelheira
4785-123 Trofa
Tel. +351 252 418431
Fax +351 252 494739
pam@mail.telepac.pt

Republic of South Africa

RUBICON
ELECTRICAL DISTRIBUTORS
4 Reith Street, Sidwell
6061 Port Elizabeth
Tel. +27 41 451-4359
Fax +27 41 451-1296
sales@rubiconelectrical.com

Romania

First Electric SRL
Str. Ritmului Nr. 1 Bis
Ap. 2, Sector 2
021675 Bucuresti
Tel. +40 21 2526218
Fax +40 21 3113193
office@firstelectric.ro

Singapore

BM Safety Singapore Pte Ltd.
Blk 3, Ang Mo Kio Industrial Park 2A
#05-06
Singapore 568050
Tel. +65 6744 8018
Fax +65 6744 1929
sales@bmsafety.com.sg

Slovakia

EUCHNER electric s.r.o.
Trnkova 3069/117h
628 00 Brno
Tel. +420 533 443-150
Fax +420 533 443-153
info@euchner.cz

Slovenia

SMM proizvodni sistemi d.o.o.
Jaskova 18
2000 Maribor
Tel. +386 2 4502326
Fax +386 2 4625160
franc.kit@smm.si

Spain

EUCHNER, S.L.
Gurutzezi 12 - Local 1
Poligono Belartza
20018 San Sebastian
Tel. +34 943 316-760
Fax +34 943 316-405
info@euchner.es

Sweden

Censit AB
Box 331
33123 Värnamo
Tel. +46 370 691010
Fax +46 370 18888
info@censit.se

Switzerland

EUCHNER AG
Falknisstrasse 9a
7320 Sargans
Tel. +41 81 720-4590
Fax +41 81 720-4599
info@euchner.ch

Taiwan

Daybreak Int'l (Taiwan) Corp.
3F, No. 124, Chung-Cheng Road
Shihlin 11145, Taipei
Tel. +886 2 8866-1234
Fax +886 2 8866-1239
day111@ms23.hinet.net

Turkey

EUCHNER Endüstriyel Emniyet
Teknolojileri Ltd. Şti.
Hattat Bahattin Sok.
Ceylan Apt. No. 13/A
Göztepe Mah.
34730 Kadıköy / Istanbul
Tel. +90 216 359-5656
Fax +90 216 359-5660
info@euchner.com.tr

United Kingdom

EUCHNER (UK) Ltd.
Unit 2 Petre Drive,
Sheffield
South Yorkshire
S4 7PZ
Tel. +44 114 2560123
Fax +44 114 2425333
sales@euchner.co.uk

USA

EUCHNER USA Inc.
6723 Lyons Street
East Syracuse, NY 13057
Tel. +1 315 701-0315
Fax +1 315 701-0319
info@euchner-usa.com

EUCHNER USA Inc.
Detroit Office
130 Hampton Circle
Rochester Hills, MI 48307
Tel. +1 248 537-1092
Fax +1 248 537-1095
info@euchner-usa.com

Germany

Augsburg

EUCHNER GmbH + Co. KG
Ingenieur- und Vertriebsbüro
Julius-Spokojny-Weg 8
86153 Augsburg
Tel. +49 821 56786540
Fax +49 821 56786541
peter.klopfer@euchner.de

Berlin

EUCHNER GmbH + Co. KG
Ingenieur- und Vertriebsbüro
Ulmenstraße 115a
12621 Berlin
Tel. +49 30 50508214
Fax +49 30 56582139
alexander.walz@euchner.de

Chemnitz

EUCHNER GmbH + Co. KG
Ingenieur- und Vertriebsbüro
Am Vogelherd 2
09627 Bobritzsch-Hilbersdorf
Tel. +49 37325 906000
Fax +49 37325 906004
jens.zehrtner@euchner.de

Düsseldorf

EUCHNER GmbH + Co. KG
Ingenieur- und Vertriebsbüro
Tippgarten 3
59427 Unna
Tel. +49 2308 9337284
Fax +49 2308 9337285
christian.schimke@euchner.de

Essen

Thomas Kreißl
fördern - steuern - regeln
Hackenbergweg 8a
45133 Essen
Tel. +49 201 84266-0
Fax +49 201 84266-66
info@kreisslessen.de

Freiburg

EUCHNER GmbH + Co. KG
Ingenieur- und Vertriebsbüro
Steige 5
79206 Breisach
Tel. +49 7664 403833
Fax +49 7664 403834
peter.seifert@euchner.de

Lübeck

EUCHNER GmbH + Co. KG
Ingenieur- und Vertriebsbüro
Am Stadtrand 13
23556 Lübeck
Tel. +49 451 88048371
Fax +49 451 88184364
martin.pape@euchner.de

Nürnberg

EUCHNER GmbH + Co. KG
Ingenieur- und Vertriebsbüro
Steiner Straße 22a
90522 Oberasbach
Tel. +49 911 6693829
Fax +49 911 6696722
ralf.paulus@euchner.de

Stuttgart

EUCHNER GmbH + Co. KG
Ingenieur- und Vertriebsbüro
Kohlhammerstraße 16
70771 Leinfelden-Echterdingen
Tel. +49 711 7597-0
Fax +49 711 7597-303
oliver.laier@euchner.de
uwe.kupka@euchner.de

Wiesbaden

EUCHNER GmbH + Co. KG
Ingenieur- und Vertriebsbüro
Adolfsallee 3
65185 Wiesbaden
Tel. +49 611 98817644
Fax +49 611 98895071
giancarlo.pasquesi@euchner.de



EUCHNER

More than safety.



Support hotline

You have technical questions about our products or how they can be used?
For further questions please contact your local sales representative.



Comprehensive download area

You are looking for more information about our products?
You can simply and quickly download operating instructions, CAD or ePLAN data and accompanying software for our products at www.euchner.com.



Customer-specific solutions

You need a specific solution or have a special requirement?
Please contact us. We can manufacture your custom product even in small quantities.



EUCHNER near you

You are looking for a contact at your location? Along with the headquarters in Leinfelden-Echterdingen, the worldwide sales network includes 17 subsidiaries and numerous representatives in Germany and abroad – you will definitely also find us near you.

www.euchner.com

EUCHNER GmbH + Co. KG

Kohlhammerstraße 16
70771 Leinfelden-Echterdingen
Germany
Tel. +49 711 7597-0
Fax +49 711 753316
info@euchner.de
www.euchner.com

E Engineering
Partner

S Systems
Integrator

V Value-Added
Distributor

248-373-1600 • morrell-group.com • orders@morrellinc.com

MI • IN • IL • OH • ON, CAN

MorrellGroup 
Evolution in Controls

EUCHNER

More than safety.