

Safety Light Curtain

Selection Guide



Application Considerations

Safety Light Curtains



deTec4 Core

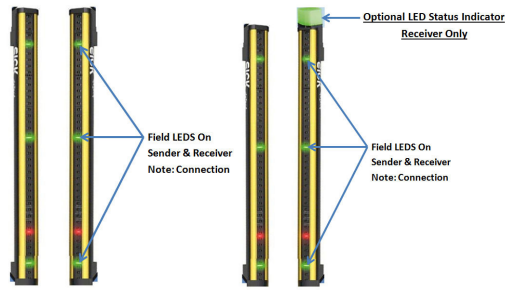

deTec4



miniTwin



C4000



deTec4-IP69K

1. Light Curtain Height (Stick Length)?
2. Range/Distance (How wide is the opening)?
3. Required Resolution?
 - 14mm Finger protection
 - 24mm - 30mm Hand Protection
 - 30mm - 70mm Leg Detection
 - ≤ 70 mm Perimeter Guarding (Area Access)
4. Is Cascading Light Curtains together required?
 - Combined Vertical & Horizontal Light Curtain Guarding (Note: Safety Laser Scanners)
5. Is Blanking required?
 - Fixed
 - Floating
6. Is "Muting" Required? - (For Entry/Exit – Temporarily Turns off the entire light curtain)
 - Note: Muting is not a light curtain function
7. Multi-Beam Perimeter Guard Light Barriers Systems (Columns & Mirrors)?
8. Special application considerations (ex: Explosion Proof Requirements)?
9. Entry/Exit - Palletizer - Explosion-proof environments - Other?

Order Process

deTec4 Core

1. Choose a set of Light Curtain Sticks - 14mm or 30mm Resolution
2. Mounting Brackets
3. T-connector - Optional, Recommended
4. Connection Cables

Usually:

- One (1) Single-ended Connection Cord
- plus
- One (1) Double-ended Connection Cord

Customer to determine the required lengths

Use 15m length connection cords if providing a budgetary quote

5. Safety Relay - Optional

- RA/AB Armor Guard
- Siemens ET200 Pro
- Other Safety IO Block (ex: Murrelektronik)

Not needed if connecting to a Safety IO Block

See the Connection Diagram below

deTec4 Light Curtain Connection with T-Connector Diagrams 14mm or 30mm Resolution

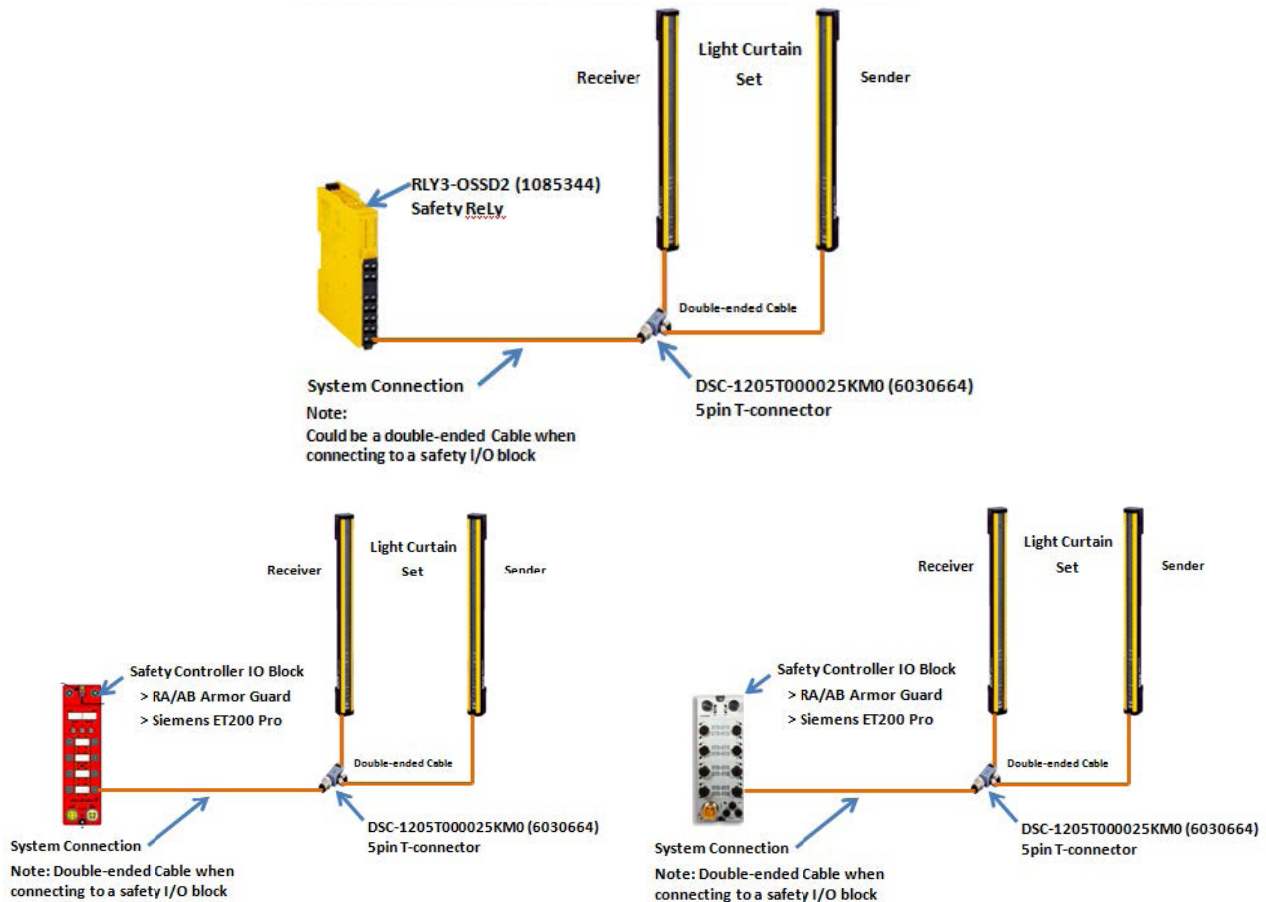

Order Process

deTec4 Core

1. Choose a set of Light Curtain Sticks - 14mm or 30mm Resolution

deTec4 Core - 14mm Resolution

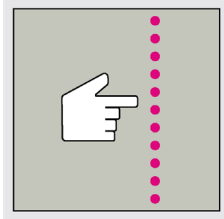

Finger Protection

- 14mm Resolution deTec4 Core Sender/Receiver
- Receiver LED Status Indicator Lamp *not available*
- >10m Range

Protective Height	Sender/Receiver Pair Model # (Part #)	Sender Model # (Part #)	Receiver Model # (Part #)
300mm	C4C-PA03010A10000 (1063362)	C4C-SA03010A10000 (1211450)	C4C-EA03010A10000 (1211463)
450mm	C4C-PA04510A10000 (1063363)	C4C-SA04510A10000 (1211469)	C4C-EA04510A10000 (1211470)
600mm	C4C-PA06010A10000 (1063364)	C4C-SA06010A10000 (1211471)	C4C-EA06010A10000 (1211472)
750mm	C4C-PA07510A10000 (1063365)	C4C-SA07510A10000 (1211473)	C4C-EA07510A10000 (1211474)
900mm	C4C-PA09010A10000 (1063366)	C4C-SA09010A10000 (1211475)	C4C-EA09010A10000 (1211515)
1050mm	C4C-PA10510A10000 (1063367)	C4C-SA10510A10000 (1211476)	C4C-EA10510A10000 (1211477)
1200mm	C4C-PA12010A10000 (1063368)	C4C-SA12010A10000 (1211478)	C4C-EA12010A10000 (1211479)
1350mm	C4C-PA13510A10000 (1063369)	C4C-SA13510A10000 (1211480)	C4C-EA13510A10000 (1211481)
1500mm	C4C-PA15010A10000 (1063370)	C4C-SA15010A10000 (1211482)	C4C-EA15010A10000 (1211483)
1650mm	C4C-PA16510A10000 (1063371)	C4C-SA16510A10000 (1211484)	C4C-EA16510A10000 (1211485)
1800mm	C4C-PA18010A10000 (1063372)	C4C-SA18010A10000 (1211486)	C4C-EA18010A10000 (1211487)
1950mm	C4C-PA19510A10000 (1063373)	C4C-SA19510A10000 (1211488)	C4C-EA19510A10000 (1211489)
2100mm	C4C-PA21010A10000 (1063374)	C4C-SA21010A10000 (1211490)	C4C-EA21010A10000 (1211491)

deTec4 Core - 30mm Resolution

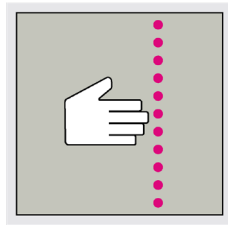

Hand Protection

- 30mm Resolution deTec4 Core Sender/Receiver
- Receiver LED Status Indicator Lamp *not available*
- >15m Range

Protective Height	Sender/Receiver Pair Model # (Part #)	Sender Model # (Part #)	Receiver Model # (Part #)
300mm	C4C-PA03030A10000 (1063375)	C4C-SA03030A10000 (1211462)	C4C-EA03030A10000 (1211464)
450mm	C4C-PA04530A10000 (1063376)	C4C-SA04530A10000 (1211492)	C4C-EA04530A10000 (1211493)
600mm	C4C-PA06030A10000 (1063377)	C4C-SA06030A10000 (1211494)	C4C-EA06030A10000 (1211495)
750mm	C4C-PA07530A10000 (1063378)	C4C-SA07530A10000 (1211496)	C4C-EA07530A10000 (1211497)
900mm	C4C-PA09030A10000 (1063379)	C4C-SA09030A10000 (1211498)	C4C-EA09030A10000 (1211516)
1050mm	C4C-PA10530A10000 (1063380)	C4C-SA10530A10000 (1211499)	C4C-EA10530A10000 (1211500)
1200mm	C4C-PA12030A10000 (1063381)	C4C-SA12030A10000 (1211501)	C4C-EA12030A10000 (1211502)
1350mm	C4C-PA13530A10000 (1063382)	C4C-SA13530A10000 (1211503)	C4C-EA13530A10000 (1211504)
1500mm	C4C-PA15030A10000 (1063383)	C4C-SA15030A10000 (1211505)	C4C-EA15030A10000 (1211506)
1650mm	C4C-PA16530A10000 (1063384)	C4C-SA16530A10000 (1211507)	C4C-EA16530A10000 (1211508)
1800mm	C4C-PA18030A10000 (1063385)	C4C-SA18030A10000 (1211509)	C4C-EA18030A10000 (1211510)
1950mm	C4C-PA19530A10000 (1063386)	C4C-SA19530A10000 (1211511)	C4C-EA19530A10000 (1211512)
2100mm	C4C-PA21030A10000 (1063387)	C4C-SA21030A10000 (1211513)	C4C-EA21030A10000 (1211514)

2. Mounting Brackets



Model # (Part #)	Qty. Required	Description
BEF-3SHABPKU4 (2098710)	1	Set of (4) QuickFix Mounting Brackets (Non-Adjustable)

Please Note: These brackets are not adjustable, which makes it difficult to align the light curtains. This is particularly difficult at long ranges or when the tooling frame is not square or level. Due to these difficulties, FlexFix Mounting Brackets, which are adjustable, are recommended.



Model # (Part #)	Qty. Required	Description
BEF-1SHABPKU4 (2066614)	1	Set of (4) FlexFix (Adjustable) Mounting Brackets, M5 Screws

3. T-Connector - Optional, Recommended



Model # (Part #)	Qty. Required	Description
DSC-1205T000025KM0 (6030664)	1	5pin T-connector with: (1) 5pin-M12 Straight Male (2) 5pin-M12 Straight Female Connectors for split connection to sender & receiver

4. Connection Cables - 2 Required

Most Common Selection:

- One (1) Single-ended Connection Cord
plus

- One (1) Double-ended Connection Cord
Customer to determine the required lengths

Use 15m length connection cords if providing a budgetary quote



(A-Coded)

Model # (Part #)	Qty. Required	Description
YF2A15-020VB5XLEAX (2096239)	1	2m Single-ended PVC Cable with 5pin-M12 Female Connector
YF2A15-030UB5XLEAX (2104367)	1	3m Single-ended PUR Cable with 5pin-M12 Female Connector
YF2A15-050VB5XLEAX (2096240)	1	5m Single-ended PVC Cable with 5pin-M12 Female Connector
YF2A15-100VB5XLEAX (2096241)	1	10m Single-ended PVC Cable with 5pin-M12 Female Connector
YF2A15-150VB5XLEAX (2096242)	1	15m Single-ended PVC Cable with 5pin-M12 Female Connector
YF2A15-200UB5XLEAX (2095614)	1	20m Single-ended PVC Cable with 5pin-M12 Female Connector
YF2A15-300UB5XLEAX (2095621)	1	30m Single-ended PUR Cable with 5pin-M12 Female Connector



Model # (Part #)	Qty. Required	Description
YF2A15-C60UB5M2A15 (2096006)	1	0.6m Double-ended PUR Cable with 5pin-M12 Straight Male & Female Connectors
YF2A15-010UB5M2A15 (2096007)	1	1m Double-ended PUR Cable with 5pin-M12 Straight Male & Female Connectors
YF2A15-015UB5M2A15 (2096008)	1	1.5m Double-ended PUR Cable with 5pin-M12 Straight Male & Female Connectors
YF2A15-020UB5M2A15 (2096009)	1	2m Double-ended PUR Cable with 5pin-M12 Straight Male & Female Connectors
YF2A15-050UB5M2A15 (2096010)	1	5m Double-ended PUR Cable with 5pin-M12 Straight Male & Female Connectors
YF2A15-100UB5M2A15 (2096011)	1	10m Double-ended PUR Cable with 5pin-M12 Straight Male & Female Connectors
YF2A15-150UB5M2A15 (2096171)	1	15m Double-ended PUR Cable with 5pin-M12 Straight Male & Female Connectors
YF2A15-200UB5M2A15 (2095844)	1	20m Double-ended PUR Cable with 5pin-M12 Straight Male & Female Connectors

5. Safety Relay - Optional

- RA/AB Armor Guard
- Siemens ET200 Pro
- Other Safety IO Block (ex: Murrelektronik)

Not needed if connecting to a Safety IO Block

See the Connection Diagram of RLY3-OSSD2 at safety light curtain with manual resett and external device monitoring below

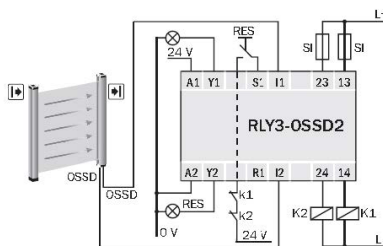

Model # (Part #)	Qty. Required	Description
RLY3-OSSD2 (1085344)	1	Safety ReLy for OSSD Output Safety Sensors with: <ul style="list-style-type: none"> • Auto / Manual Reset • 2 NO Safety Output Contacts (10-250vdc) • 1 Control Input (11-30vdc) • 1 PNP Control Output • 1 PNP Signaling Output • 16.8-30vdc • Plug-in spring terminals

Order Process

deTec4

1. Choose a set of “Host” Light Curtain Sticks - 14mm or 30mm Resolution
2. Mounting Brackets
3. Choose System Plugs
 - Up to 3 Sets of Light Curtains can be Cascaded together as a single system
 - “Host” Set plus “Guest 1” Set & “Guest 2” Set (Usually only two sets are cascaded together)
 - If “Cascading – Guest 1” Sticks – Repeat Steps 1– 3 below
 - 1b Choose a Set of “Guest 1” Sticks - 14mm or 30mm Resolution
 - 2b Mounting Brackets
 - 3b Choose System Plugs
 - If “Cascading – Guest 2” Sticks – Repeat Steps 1– 3 below (Same as Guest 1)
 - 1c Choose a Set of “Guest 2” Sticks - 14mm or 30mm Resolution
 - 2c Mounting Brackets
 - 3c Choose System Plugs
4. T-connector - Optional, Recommended
5. Connection Cables
 - Usually:
 - One (1) Single-ended Connection Cord
 - plus*
 - One (1) Double-ended Connection Cord
 - Customer to determine the required lengths
 - Use 15m length connection cords if providing a budgetary quote
6. Safety Relay - Optional
 - RA/AB Armor Guard
 - Siemens ET200 Pro
 - Or other Safety IO Blocks (ex: Murrelektronik)

Not needed if connecting to a Safety IO Block
See the Connection Diagrams on page 9

deTec4 Light Curtain Connections with a T-connector

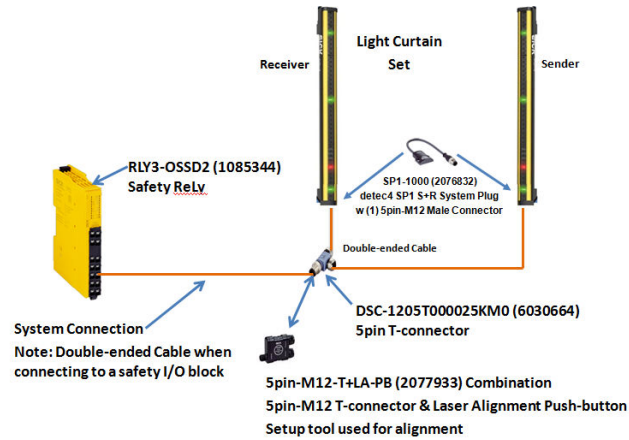

deTec4 Light Curtain Connections with a T-connector

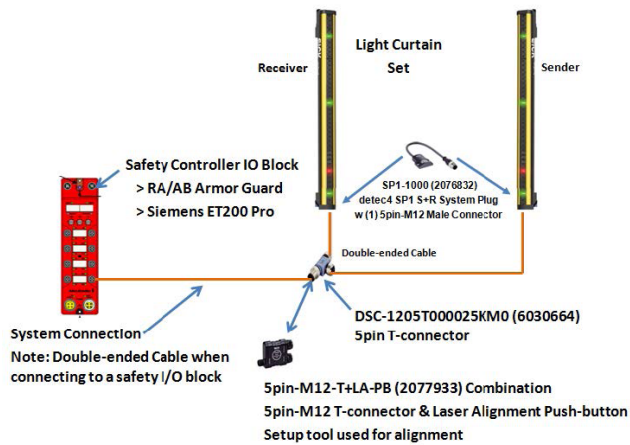

deTec4 Light Curtain Connections with a T-connector

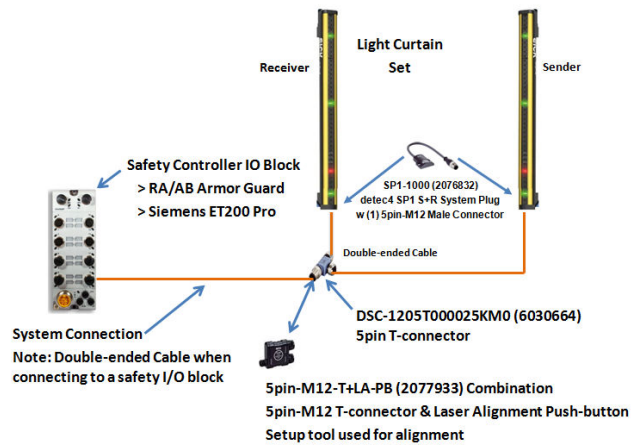

**deTec Light Curtain Cascaded System
T-connector + Laser Alignment Solution**

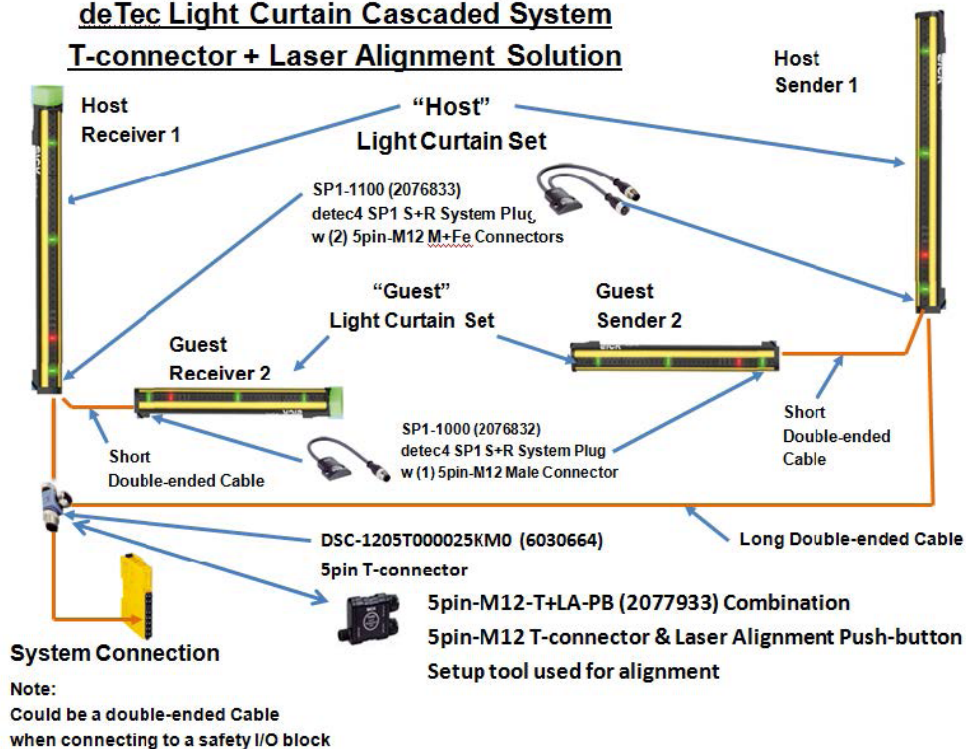

Order Process

deTec4

1. Choose a set of “Host” Light Curtain Sticks - 14mm or 30mm Resolution

deTec4 - 14mm Resolution without LED

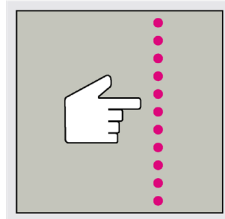
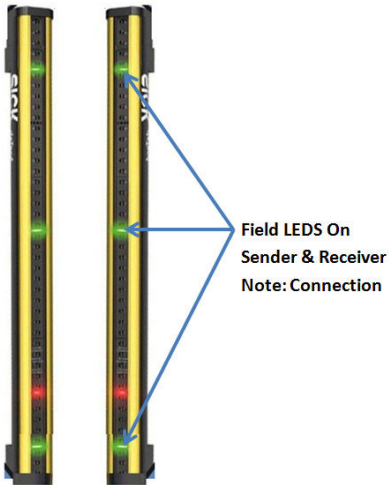

Finger Protection

- 14mm Resolution deTec4 Sender/Receiver
- **Without Receiver LED Status Indicator Lamp**
- >20m Range
- Ordered Separately, Not Sold in Pairs

Protective Height	Sender Model # (Part #)	Receiver Model # (Part #)
300mm	C4P-SA03011A00 (1220084)	C4P-EA03011C00 (1220097)
450mm	C4P-SA04511A00 (1220085)	C4P-EA04511C00 (1220098)
600mm	C4P-SA06011A00 (1220086)	C4P-EA06011C00 (1220099)
750mm	C4P-SA07511A00 (1220087)	C4P-EA07511C00 (1220100)
900mm	C4P-SA09011A00 (1220088)	C4P-EA09011C00 (1220101)
1050mm	C4P-SA10511A00 (1220089)	C4P-EA10511C00 (1220102)
1200mm	C4P-SA12011A00 (1220090)	C4P-EA12011C00 (1220103)
1350mm	C4P-SA13511A00 (1220091)	C4P-EA13511C00 (1220104)
1500mm	C4P-SA15011A00 (1220092)	C4P-EA15011C00 (1220105)
1650mm	C4P-SA16511A00 (1220093)	C4P-EA16511C00 (1220106)
1800mm	C4P-SA18011A00 (1220094)	C4P-EA18011C00 (1220121)
1950mm	C4P-SA19511A00 (1220095)	C4P-EA19511C00 (1220107)
2100mm	C4P-SA21011A00 (1220096)	C4P-EA21011C00 (1220108)

deTec4 - 14mm Resolution with LED

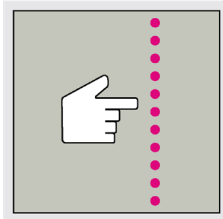
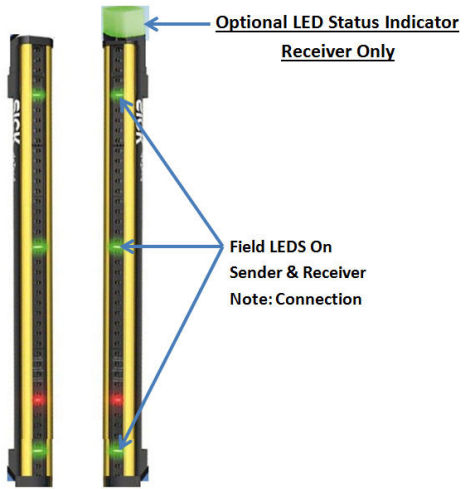

Finger Protection

- 14mm Resolution deTec4 Sender/Receiver
- **With Receiver LED Status Indicator Lamp**
- >20m Range
- Ordered Separately, Not Sold in Pairs

Protective Height	Sender Model # (Part #)	Receiver Model # (Part #)
300mm	C4P-SA03011A00 (1220084)	C4P-EA03011D00 (1220109)
450mm	C4P-SA04511A00 (1220085)	C4P-EA04511D00 (1220110)
600mm	C4P-SA06011A00 (1220086)	C4P-EA06011D00 (1220111)
750mm	C4P-SA07511A00 (1220087)	C4P-EA07511D00 (1220112)
900mm	C4P-SA09011A00 (1220088)	C4P-EA09011D00 (1220113)
1050mm	C4P-SA10511A00 (1220089)	C4P-EA10511D00 (1220114)
1200mm	C4P-SA12011A00 (1220090)	C4P-EA12011D00 (1220115)
1350mm	C4P-SA13511A00 (1220091)	C4P-EA13511D00 (1220116)
1500mm	C4P-SA15011A00 (1220092)	C4P-EA15011D00 (1220117)
1650mm	C4P-SA16511A00 (1220093)	C4P-EA16511D00 (1220118)
1800mm	C4P-SA18011A00 (1220094)	C4P-EA18011D00 (1220122)
1950mm	C4P-SA19511A00 (1220095)	C4P-EA19511D00 (1220119)
2100mm	C4P-SA21011A00 (1220096)	C4P-EA21011D00 (1220120)

deTec4 - 30mm Resolution without LED

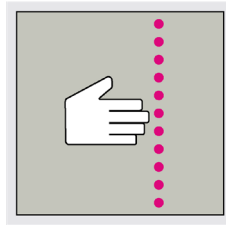
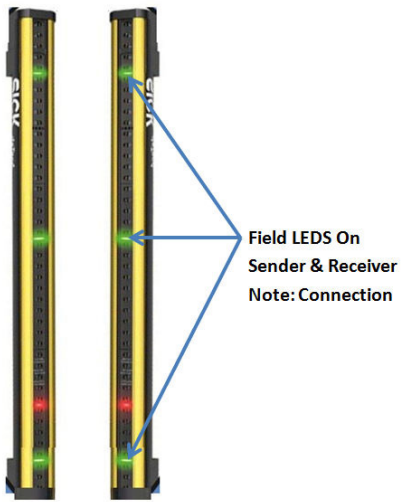

Hand Protection

- 30mm Resolution deTec4 Sender/Receiver
- **Without Receiver LED Status Indicator Lamp**
- >30m Range
- Ordered Separately, Not Sold in Pairs

Protective Height	Sender Model # (Part #)	Receiver Model # (Part #)
300mm	C4P-SA03031A00 (1220123)	C4P-EA03031C00 (1220137)
450mm	C4P-SA04531A00 (1220124)	C4P-EA04531C00 (1220138)
600mm	C4P-SA06031A00 (1220125)	C4P-EA06031C00 (1220139)
750mm	C4P-SA07531A00 (1220126)	C4P-EA07531C00 (1220140)
900mm	C4P-SA09031A00 (1220127)	C4P-EA09031C00 (1220141)
1050mm	C4P-SA10531A00 (1220128)	C4P-EA10531C00 (1220142)
1200mm	C4P-SA12031A00 (1220129)	C4P-EA12031C00 (1220143)
1350mm	C4P-SA13531A00 (1220130)	C4P-EA13531C00 (1220144)
1500mm	C4P-SA15031A00 (1220131)	C4P-EA15031C00 (1220145)
1650mm	C4P-SA16531A00 (1220132)	C4P-EA16531C00 (1220146)
1800mm	C4P-SA18031A00 (1220134)	C4P-EA18031C00 (1220147)
1950mm	C4P-SA19531A00 (1220135)	C4P-EA19531C00 (1220148)
2100mm	C4P-SA21031A00 (1220136)	C4P-EA21031C00 (1220149)

deTec4 - 30mm Resolution with LED

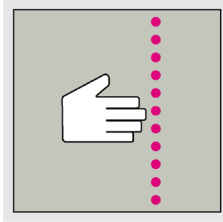
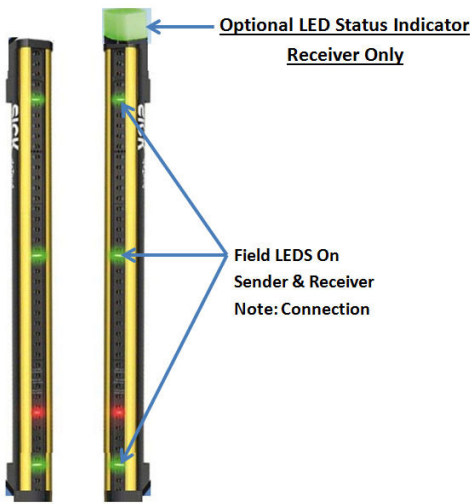

Hand Protection

- 30mm Resolution deTec4 Sender/Receiver
- **With Receiver LED Status Indicator Lamp**
- >30m Range
- Ordered Separately, Not Sold in Pairs

Protective Height	Sender Model # (Part #)	Receiver Model # (Part #)
300mm	C4P-SA03031A00 (1220123)	C4P-EA03031D00 (1220150)
450mm	C4P-SA04531A00 (1220124)	C4P-EA04531D00 (1220151)
600mm	C4P-SA06031A00 (1220125)	C4P-EA06031D00 (1220152)
750mm	C4P-SA07531A00 (1220126)	C4P-EA07531D00 (1220153)
900mm	C4P-SA09031A00 (1220127)	C4P-EA09031D00 (1220154)
1050mm	C4P-SA10531A00 (1220128)	C4P-EA10531D00 (1220155)
1200mm	C4P-SA12031A00 (1220129)	C4P-EA12031D00 (1220156)
1350mm	C4P-SA13531A00 (1220130)	C4P-EA13531D00 (1220157)
1500mm	C4P-SA15031A00 (1220131)	C4P-EA15031D00 (1220158)
1650mm	C4P-SA16531A00 (1220132)	C4P-EA16531D00 (1220159)
1800mm	C4P-SA18031A00 (1220134)	C4P-EA18031D00 (1220160)
1950mm	C4P-SA19531A00 (1220135)	C4P-EA19531D00 (1220161)
2100mm	C4P-SA21031A00 (1220136)	C4P-EA21031D00 (1220162)

2. Mounting Brackets

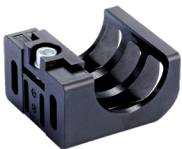

Model # (Part #)	Qty. Required	Description
BEF-1SHABPKU4 (2066614)	1	Set of (4) FlexFix (Adjustable) Mounting Brackets, M5 Screws

3. System Plugs - 2 Required for Each Sender/Receiver Set

Use SP1-1000 (2076832) on Stand-alone or Last "Guest" Set

Use SP1-1100 (2076833) on Cascade "Host" Set and First "Guest" Set



Model # (Part #)	Qty. Required	Description
SP1-1000 (2076832)	2	deTec4 SP1 Sender-Receiver System Plug with: (1) 5pin-M12 Male Connector



Model # (Part #)	Qty. Required	Description
SP1-1100 (2076833)	2	deTec4 SP1 Sender-Receiver System Plug with: (1) 5pin-M12 Male Connector (1) 5pin-M12 Female Connector (RES, EDM, ADO, IO-Link, Cascading)

Special Application Features System Plugs



Model # (Part #)	Qty. Required	Description
SP1-1200 (2076834)	1	deTec4 SP1 Sender-Receiver System Plug with: (1) 8pin-M12 Male Connector (RES, EDM, ADO)



Model # (Part #)	Qty. Required	Description
SP1-1300 (2076835)	1	deTec4 SP1 Sender-Receiver System Plug with: (1) 8pin-M12 Male Connector (1) 5pin-M12 Female Connector (RES, EDM, ADO, IO-Link, Cascading)



Model # (Part #)	Qty. Required	Description
SP2-2000 (2093097)	1	deTec4 SP2 Receiver System Plug with: (1) 5pin-M12 Male Connector



Model # (Part #)	Qty. Required	Description
SP2-2100 (2093098)	1	deTec4 SP2 Receiver System Plug with: (1) 5pin-M12 Male Connector (1) 5pin-M12 Female Connector (RES, EDM, ADO, IO-Link, Cascading, smart presence detection, muting)



Model # (Part #)	Qty. Required	Description
SP2-2200 (2093099)	1	deTec4 SP2 Sender-Receiver System Plug with: (1) 8pin-M12 Male Connector (RES, EDM, ADO)



Model # (Part #)	Qty. Required	Description
SP3-2300 (2093100)	1	deTec4 SP2 Receiver System Plug with: (1) 8pin-M12 Male Connector (1) 5pin-M12 Female Connector (RES, EDM, ADO, IO-Link, Cascading, smart presence detection, muting)

Up to 3 Sets of Light Curtains can be Cascaded together as a single system
 “Host” Set plus “Guest 1” Set & “Guest 2” Set (Usually only two sets are cascaded together)

If “Cascading – Guest 1” Sticks – Repeat Steps 1– 3 below

- 1b Choose a Set of “Guest 1” Sticks - 14mm or 30mm Resolution
- 2b Mounting Brackets
- 3b Choose System Plugs

If “Cascading – Guest 2” Sticks – Repeat Steps 1– 3 below (Same as Guest 1)

- 1c Choose a Set of “Guest 2” Sticks - 14mm or 30mm Resolution
- 2c Mounting Brackets
- 3c Choose System Plugs

4. T-Connector - Optional, Recommended



Model # (Part #)	Qty. Required	Description
DSC-1205T000025KM0 (6030664)	1	5pin T-connector with: (1) 5pin-M12 Straight Male (2) 5pin-M12 Straight Female Connectors for split connection to sender & receiver

5. Connection Cables - 2 Required

Most Common Selection:

- One (1) Single-ended Connection Cord
- plus*
- One (1) Double-ended Connection Cord

Customer to determine the required lengths

Use 15m length connection cords if providing a budgetary quote



(A-Coded)

Model # (Part #)	Qty. Required	Description
YF2A15-020VB5XLEAX (2096239)	1	2m Single-ended PVC Cable with 5pin-M12 Female Connector
YF2A15-030UB5XLEAX (2104367)	1	3m Single-ended PUR Cable with 5pin-M12 Female Connector
YF2A15-050VB5XLEAX (2096240)	1	5m Single-ended PVC Cable with 5pin-M12 Female Connector
YF2A15-100VB5XLEAX (2096241)	1	10m Single-ended PVC Cable with 5pin-M12 Female Connector
YF2A15-150VB5XLEAX (2096242)	1	15m Single-ended PVC Cable with 5pin-M12 Female Connector
YF2A15-200UB5XLEAX (2095614)	1	15m Single-ended PVC Cable with 5pin-M12 Female Connector
YF2A15-300UB5XLEAX (2095621)	1	30m Single-ended PUR Cable with 5pin-M12 Female Connector



Model # (Part #)	Qty. Required	Description
YF2A15-C60UB5M2A15 (2096006)	1	0.6m Double-ended PUR Cable with 5pin-M12 Straight Male & Female Connectors
YF2A15-010UB5M2A15 (2096007)	1	1m Double-ended PUR Cable with 5pin-M12 Straight Male & Female Connectors
YF2A15-015UB5M2A15 (2096008)	1	1.5m Double-ended PUR Cable with 5pin-M12 Straight Male & Female Connectors
YF2A15-020UB5M2A15 (2096009)	1	2m Double-ended PUR Cable with 5pin-M12 Straight Male & Female Connectors
YF2A15-050UB5M2A15 (2096010)	1	5m Double-ended PUR Cable with 5pin-M12 Straight Male & Female Connectors
YF2A15-100UB5M2A15 (2096011)	1	10m Double-ended PUR Cable with 5pin-M12 Straight Male & Female Connectors
YF2A15-150UB5M2A15 (2096171)	1	15m Double-ended PUR Cable with 5pin-M12 Straight Male & Female Connectors
YF2A15-200UB5M2A15 (2095844)	1	20m Double-ended PUR Cable with 5pin-M12 Straight Male & Female Connectors

6. Safety Relay - Optional

- RA/AB Armor Guard
- Siemens ET200 Pro
- Other Safety IO Block (ex: Murrelektronk)

Not needed if connecting to a Safety IO Block

See the Connection Diagram of RLY3-OSSD2 at safety light curtain with manual resett and external device monitoring below

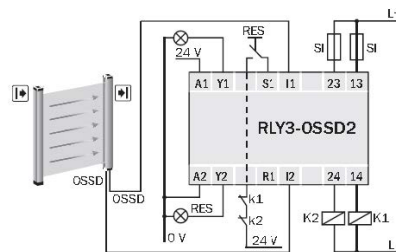

Model # (Part #)	Qty. Required	Description
RLY3-OSSD2 (1085344)	1	Safety ReLy for OSSD Output Safety Sensors with: <ul style="list-style-type: none"> • Auto / Manual Reset • 2 NO Safety Output Contacts (10-250vdc) • 1 Control Input (11-30vdc) • 1 PNP Signaling Output • 16.8-30vdc • Plug-in spring terminals

deTec4 Laser Alignment Accessories:
 Does not apply for deTec4 Core Light Curtains



Model # (Part #)	Qty. Required	Description
5pin-M12-T+LA-PB (2077933)	1	<p>5pin T-connector with:</p> <ul style="list-style-type: none"> (1) 5pin-M12 Straight Male (2) 5pin-M12 Straight Female Connectors for split connection to sender & receiver <p>The combination 5pin T-connector & Laser Alignment Push-button splits the cable connection from the control cabinet between the sender & receiver</p> <ul style="list-style-type: none"> • acting as a distributor for normal operation and • allows for switching on & off the deTec4 Prime integrated laser alignment tool while disabling the OSSD O/Ps <p>Note: Only one (1) 5pin-M12 Laser Alignment Push-button is required at a facility for setup purposes</p>

Additional Resources



deTec Brochure



deTec Landing Page

Sensor Intelligence: In Stock. Shipped Fast. Competitive Pricing.

Morrell's exclusive program stocks and ships/delivers the most common SICK Laser Sensors and Light Curtains at competitive prices.

deTec safety light curtains



deTec / deTec4 Core / Pair
Protective field height: 300mm
Resolution: 30mm
Type: C4C-PA03030A10000
Part Number: 1063375

deTec / deTec4 Core / Pair
Protective field height: 450mm
Resolution: 30mm
Type: C4C-PA04530A10000
Part Number: 1063376

deTec / deTec4 Core / Pair
Protective field height: 600mm
Resolution: 30mm
Type: C4C-PA06030A10000
Part Number: 1063377

deTec / deTec4 Core / Pair
Protective field height: 900mm
Resolution: 30mm
Type: C4C-PA09030A10000
Part Number: 1063379

deTec / deTec4 Core / Pair
Protective field height: 1200mm
Resolution: 30mm
Type: C4C-PA12030A10000
Part Number: 1063381

deTec / deTec4 Core / Pair
Protective field height: 1500mm
Resolution: 30mm
Type: C4C-PA15030A10000
Part Number: 1063383

All listed products include sender, receiver, and mounting bracket kit.

microScan3



microScan3 Core /microScan3 Core – EtherNet/IP™
Protective field range: 5.5 m
Number of fields: 8
Type: MICS3-ABAZ40IZ1P01
Part Number: 1082016

microScan3 Core / microScan3 Core I/O
Protective field range: 5.5 m
Number of fields: 8
Type: MICS3-AAAZ55AZ1P01
Part Number: 1075843

microScan3 Core / microScan3 Core – PROFINET
Protective field range: 5.5 m
Number of fields: 8
Type: MICS3-ACAZ55PZ1P01
Part Number: 1083010

microScan3 Pro / microScan3 Pro – EtherNet/IP™
Protective field range: 9 m
Number of fields: 128
Type: MICS3-CBAZ90IZ1P01
Part number: 1094461

microScan3 Core / microScan3 Core I/O
Protective field range: 9 m
Number of fields: 8
Type: MICS3-AAAZ90AZ1P01
Part number: 1089492

microScan3 Pro / microScan3 Pro – PROFINET
Protective field range: 9 m
Number of fields: 128
Type: MICS3-CBAZ90PZ1P01
Part number: 1094463

S3000 Standard and Advanced



S3000 Standard / Sensor head with I/O module
Protective field range: 4 m
Number of field sets: 1
Type: S30A-4011BA
Part Number: 1028934

S3000 Standard / Sensor head with I/O module
Protective field range: 5.5 m
Number of field sets: 1
Type: S30A-6011BA
Part Number: 1023546

S3000 Standard / Sensor head with I/O module
Protective field range: 7 m
Number of field sets: 1
Type: S30A-7011BA
Part Number: 1023890

S3000 Advanced / Sensor head with I/O module
Protective field range: 5.5 m
Number of field sets: 4
Type: S30A-6011CA
Part Number: 1023547

S3000 Advanced / Sensor head with I/O module
Protective field range: 7 m
Number of field sets: 4
Type: S30A-7011CA
Part Number: 1023891

S3000 Advanced / Sensor head with I/O module
Protective field range: 4 m
Number of field sets: 4
Type: S30A-4011CA
Part Number: 1028935

To order contact 248-373-1600, email orders@morrellinc.com, or chat online at morrell-group.com/sick-safety



Moving the Midwest

MICHIGAN
Auburn Hills
248-373-1600

Grand Rapids
616-583-9390

INDIANA
Indianapolis
317-849-7007

Fort Wayne
260-483-7070

ILLINOIS
Glendale Heights
630-858-4600

morrell-group.com

OHIO
Toledo
419-365-3111

info@morrellinc.com

Canada
Windsor
519-944-3877

Disclaimer

Product information contained in this document, including but not limited to specifications, availability and pricing, is provided to Morrell Group by our vendors. Morrell Group is not the source of this information and therefore does not warrant the accuracy or sufficiency thereof.