

4 PLCS Mounting Hole
 Either M5 Tap Or Can Be Used as
 Thru Hole for M4 Nut and Bolt

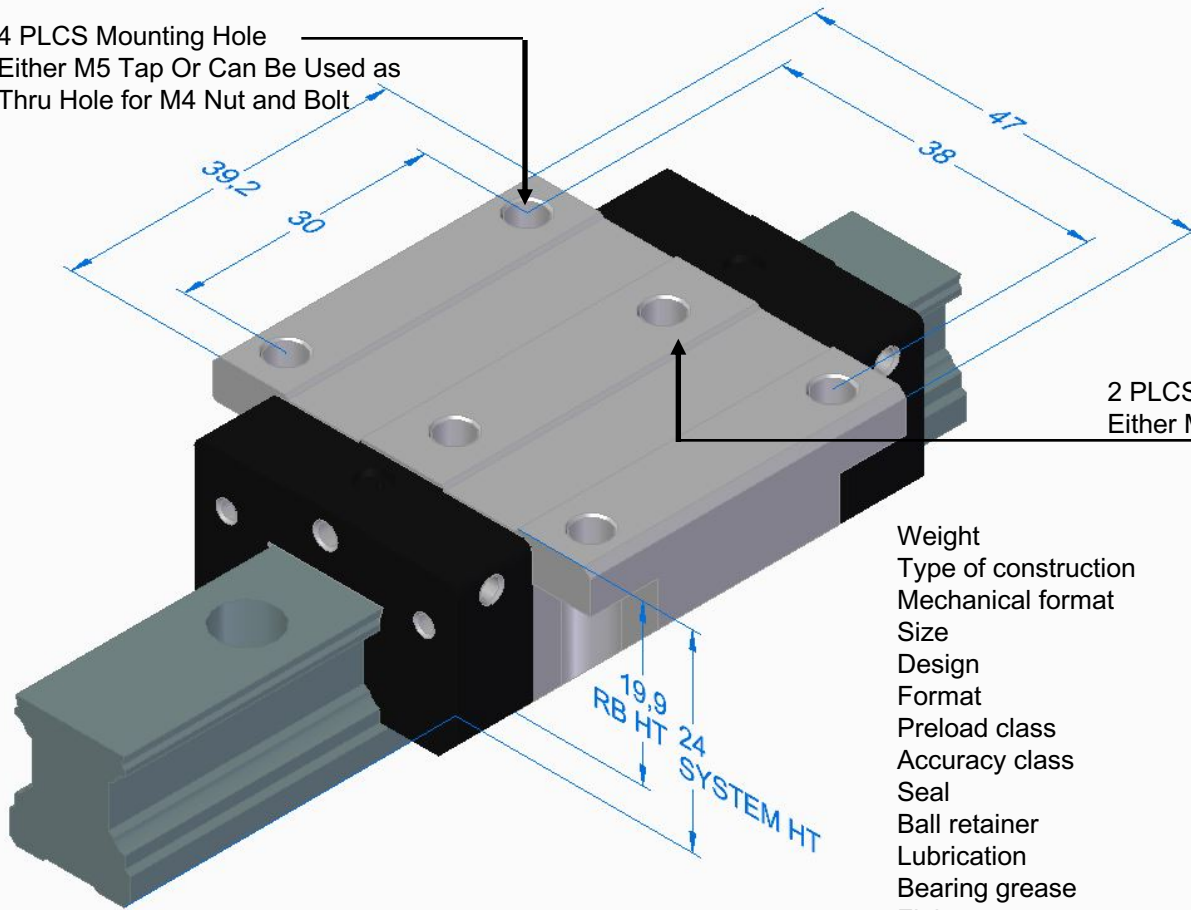

2 PLCS Mounting Hole
 Either M5 Tap



Weight	0.20 kg
Type of construction	FW runner block
Mechanical format	KWD Ball runner block
Size	15
Design	FNS Flanged, normal, standard height
Format	CS Carbon steel
Preload class	C1 low preload
Accuracy class	N Normal
Seal	SS Standard seal
Ball retainer	0 Without ball retainer
Lubrication	01 Prelubricated, preserved
Bearing grease	S1 Dynalub 510
Fitting	M6X8

10 MILLION METER RELUBRICATION SCHEDULE

<u>RATINGS</u>	<u>ENGLISH</u>
9,860 N Basic Dynamic Capacity	2220 lbs
12,700 N Static Capacity	2855 lbs
95 Nm Roll Moment Dynamic Capacity	70 ft-lbs
120 Nm Roll Moment Static Capacity	88 ft-lbs
68 Nm Pitch/Yaw Moment Dynamic Capacity	50 ft-lbs
87 Nm Pitch/Yaw Moment Static Capacity	64 ft-lbs

Bosch Rexroth BSHP Ball Rail Runner Block
 KWD-015-FNS-CS-C1-N-SS-0-01-S1-00-BX-LS-000-RS-000-01
PN: 1651-114-20



www.morrell-group.com



UNITS : mm